

VC-A71SN

Ultra HD camera (4K PTZ Video Camera)

User Manual - English

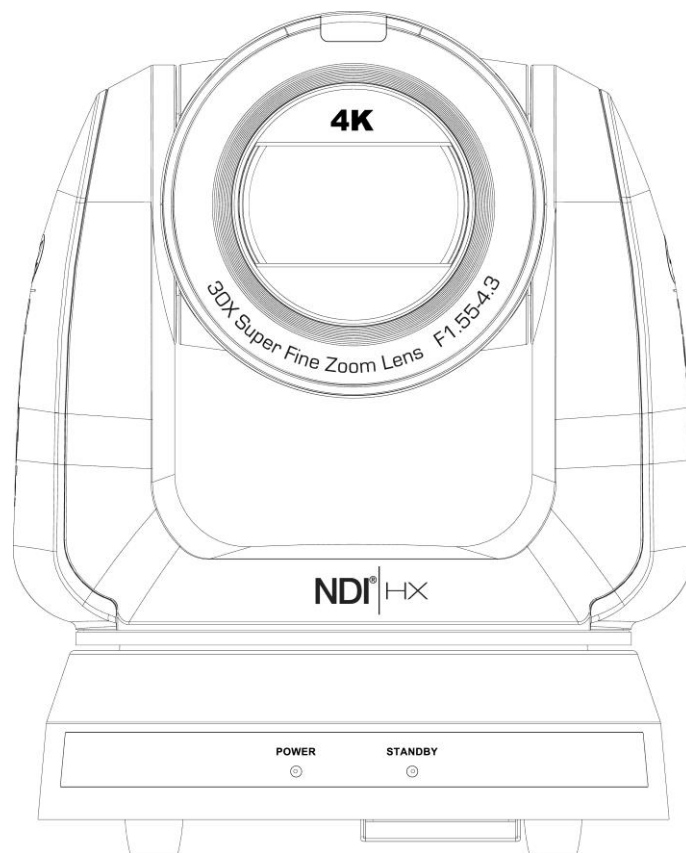

Version VCBC106d

To download the latest versions of the Quick Start Guide, multilingual user manual, software, driver, etc., please visit Lumens
<https://www.MyLumens.com/support>

Table of Contents

Chapter 1	Package Contents	3
Chapter 2	Function Introduction	4
	2.1 I/ O functions Introduction.....	4
	2.2 Tally Lamp Function Description	6
	2.3 Description of LED indicator	6
Chapter 3	Instruction for installation	7
	3.1 Camera Size.....	7
	3.2 Preparation before installation	8
	3.3 Instruction for installation	8
	3.4 Connecting devices	13
Chapter 4	Remote Control and Setting Menu	16
	4.1 Functions of remote control	16
	4.2 Setting Menu.....	17
Chapter 5	Network Function Settings Description	21
	5.1 Connecting Camera to Network	21
	5.2 Web Page Function Description	23
Chapter 6	DIP Switch Setting	39
	6.1 DIP SWITCH	39
Chapter 7	Troubleshooting	40
Chapter 8	Safety Instructions	41
	Supplier’s Declaration of Conformity 47 CFR § 2.1077 Compliance Information	43
	Copyright Information	44

Chapter 1 Package Contents

Camera

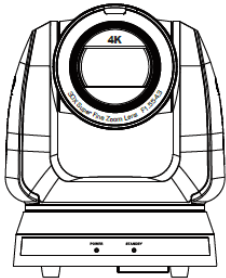

M3 Screws

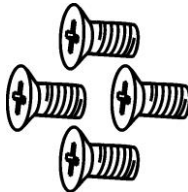

Silver x 8 / Black x 2

Remote Control

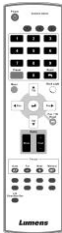

Power Cord

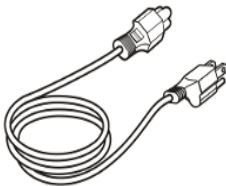

Appearance may vary depending on country / region

Power Adapter

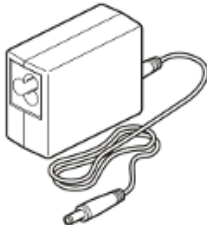

RS-422 Connector

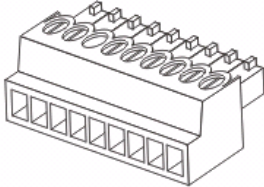

Metal Plate A

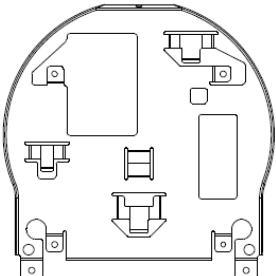

Metal Plate B

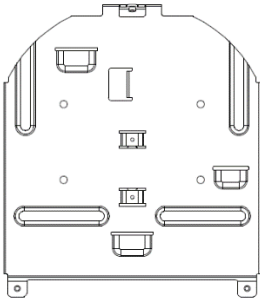

Chapter 2 Function Introduction

2.1 I/O functions Introduction

2.1.1 Front View

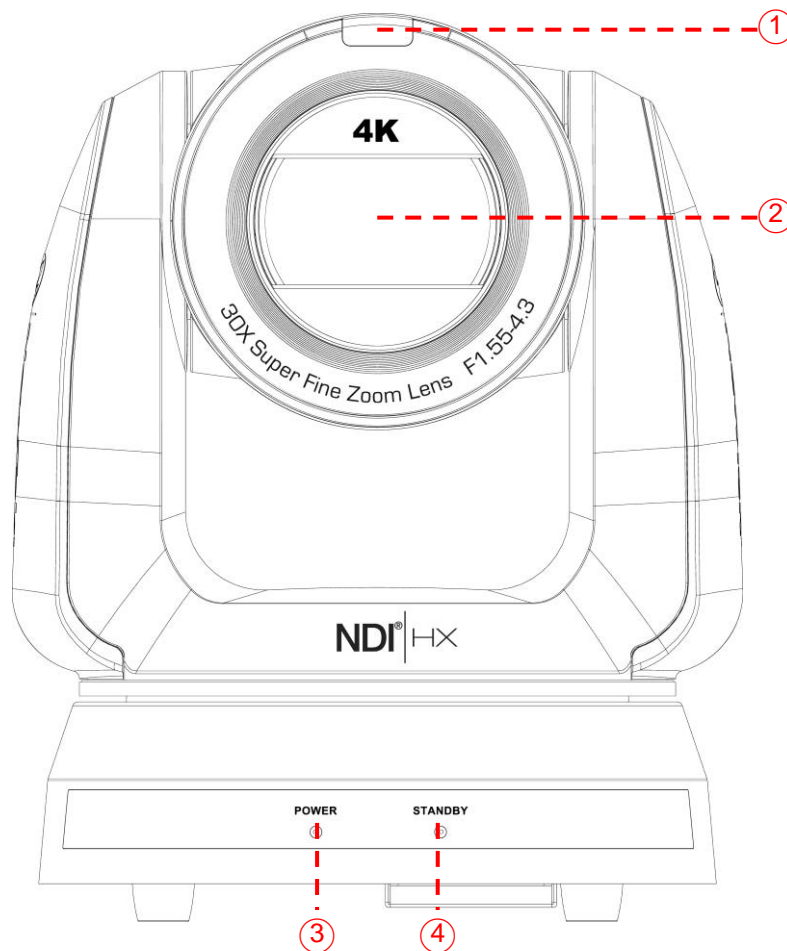

NO.	Item	Function Descriptions
1.	Tally Light	Display the Tally Lamp status of the camera
2.	Camera lens	30x HD camera lens
3.	Power LED indicator	Display the status of the camera, please refer to 2.3 Description of LED indicator
4.	Standby LED indicator	Display the status of the camera, please refer to 2.3 Description of LED indicator

2.1.2 Back View

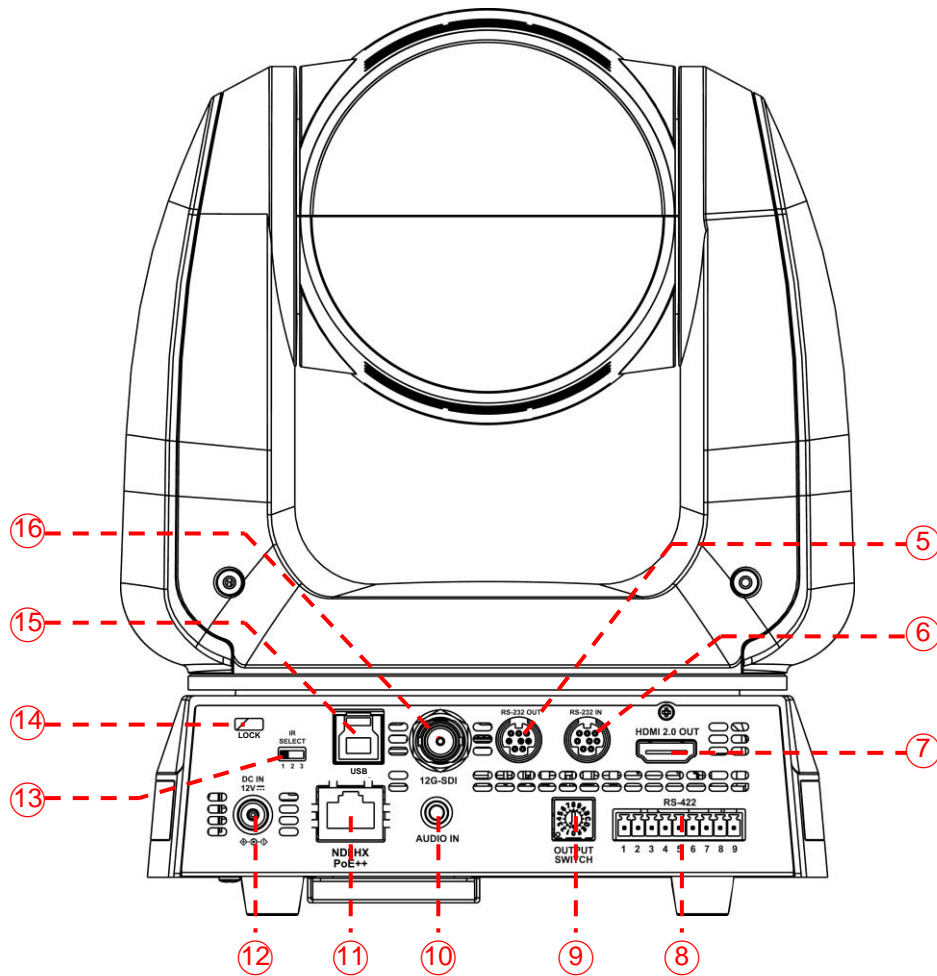

NO.	Item	Function Descriptions
5.	RS-232 output	RS-232 output port, at most 7 cameras can be connected in a serial connection
6.	RS-232 input	RS-232 input port, at most 7 cameras can be connected in a serial connection
7.	HDMI 2.0 output	HDMI 2.0 output (Audio output supported)
8.	RS-422 port	RS-422 port, at most 7 cameras can be connected in a serial connection
9.	OUTPUT SWITCH	Adjust the resolution setting. The default is 3840 x 2160/ 59.94p
10.	Audio input	Support Line In / Mic In
11.	Network port	Network cable connection port supports routers or hubs of PoE++ (IEEE 802.3bt) with power supply
12.	DC 12V power connector	AC power supply port
13.	IR SELECT	The remote control ID setting is only controlled after corresponding to the Camera Select on the remote control
14.	Kensington lock hole	Safety lock slot
15.	USB 3.0 port	Connects to the USB port of the computer and provides USB signal images <Remark> Support up to 3840 x 2160/ 29.97p
16.	12G-SDI output	12G-SDI output (Audio output supported)

2.1.3 Bottom

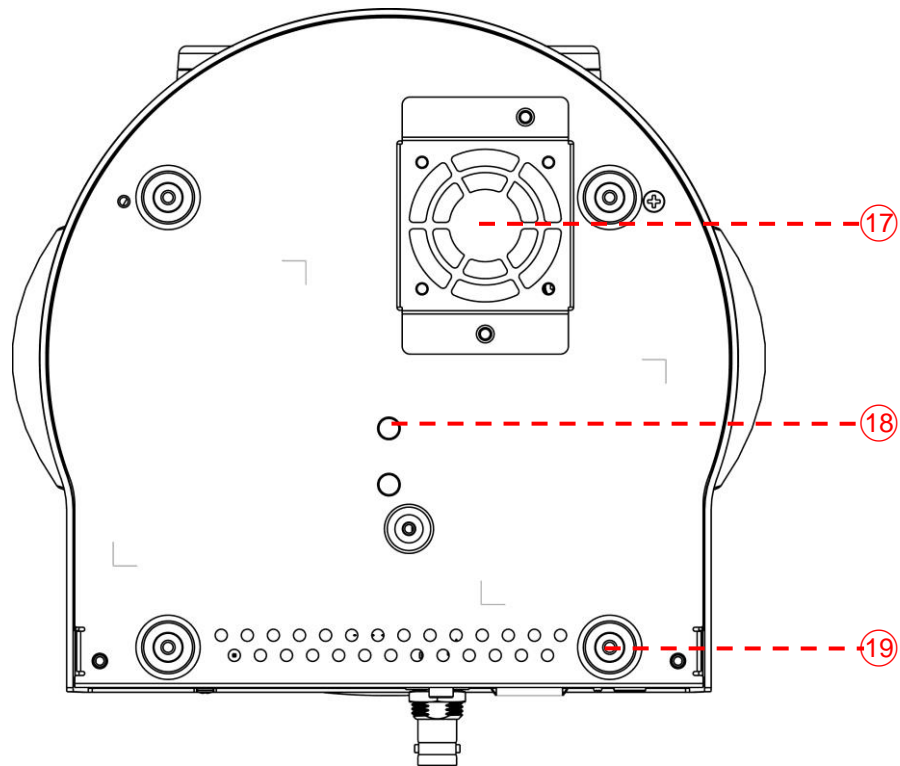

NO.	Item	Function Descriptions
17.	Mute cooling fan	The cooling fan automatically controls its rotation speed and performs cooling in cope with the operation temperature of the machine
18.	Tripod lock hole	The camera is mounted on a (specification) 1/ 4"-20 UNC tripod
19.	Rotatable foot pad	When using the metal plates of accessories, remove 4 pieces of rotatable food pads on the bottom by rotating counterclockwise, and then install the mental plates

2.2 Tally Lamp Function Description

The Tally light function may be enabled through the RS232 command. Please refer to [VC-A71SN RS-232 command set](#) document

2.3 Description of LED indicator

Status	Power	Standby
Startup in progress (initialization)	Green light	Orange light
In use	Green light	No indicator
In standby mode	No indicator	Orange light

Chapter 3 Instruction for installation

3.1 Camera Size

3.1.1 Camera Front View and Side View

- Length x Width x Height: 233 x 188 x 189 mm
- Weight: 3.0 Kg (without mental plates)

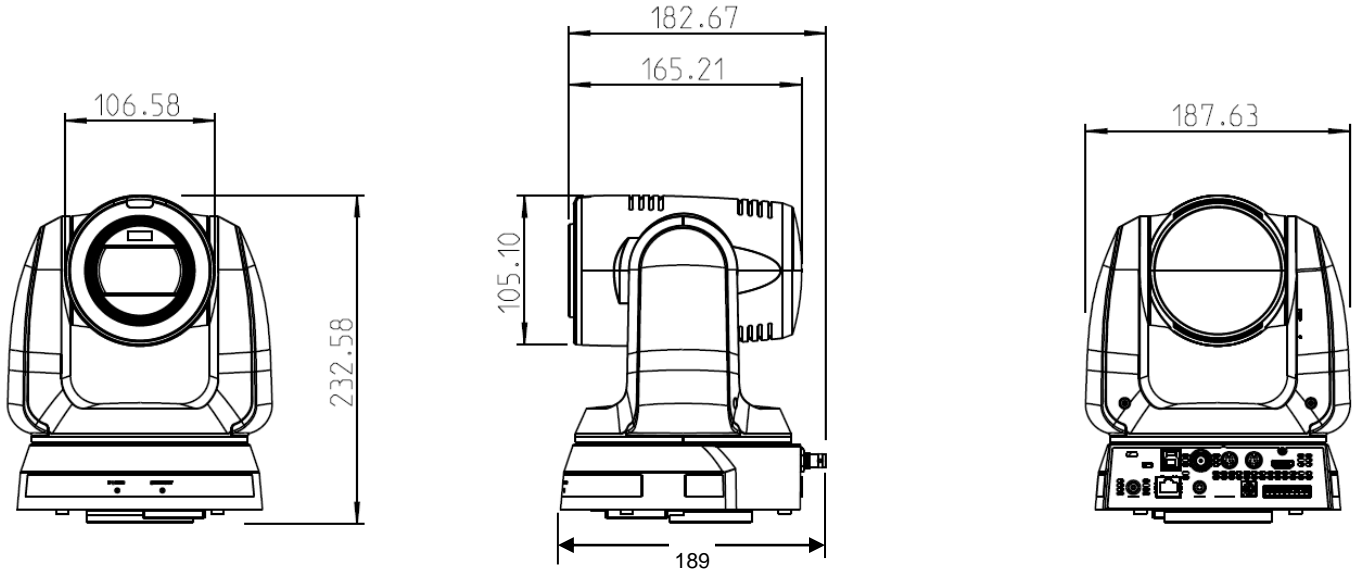

3.1.1.1 Bottom of Camera

The camera can be mounted on a 1/4"-20 UNC PTZ tripod deck by using the lock holes on the bottom for the tripod

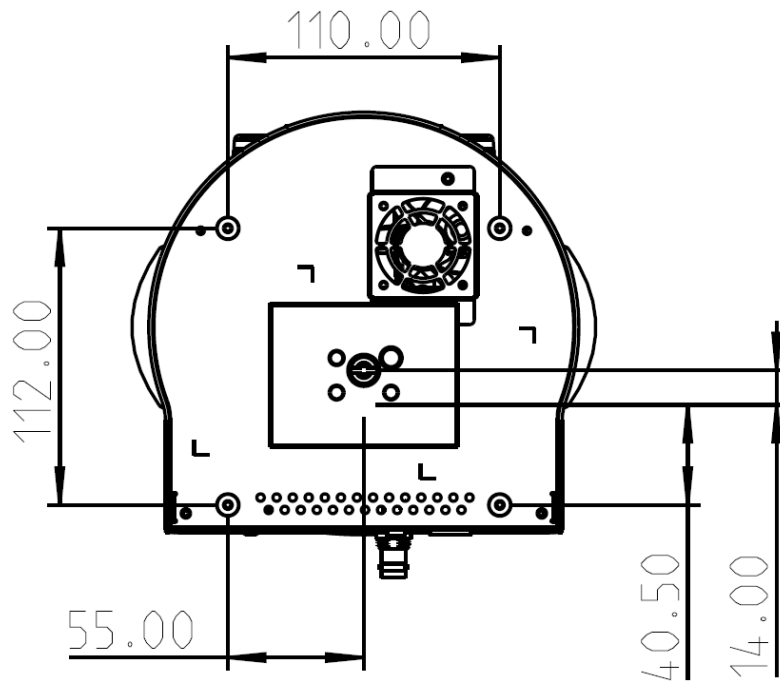

3.2 Preparation before installation

Installation and connection of HD camera requires special skills. To install by yourself, please follow necessary steps, ensure steady and tight installation of the device, and pay attention to your safety to avoid any accident.

3.2.1 Ensure the safety of the installation environment. Please do not install the device on unstable ceiling or in a place where the device is in danger of falling to avoid any accident.

3.2.2 Please check whether accessories in the box are complete or not. Please contact the supplier for any shortage, and make sure to keep the accessories in the box intact.

3.2.3 Please choose a proper place for installation of camera in advance. Please determine an installation place according to the following requirements

3.2.3.1 Confirm the position for the object to be captured.

3.2.3.2 Confirm whether the camera is set at a proper distance from other light sources.

3.3 Instruction for installation

3.3.1 Install the camera on the desk

3.3.1.1 Precautions for installation

- ◆ Please install the machine on a flat desk
- ◆ Do not grab the camera head by hand when handling the device
- ◆ Do not rotate the camera head by hand. Improper rotation may result in breakdown of the camera

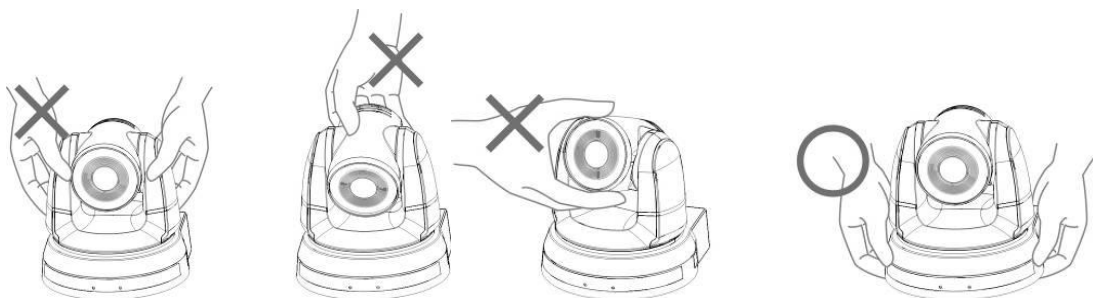

3.3.1.2 Installation steps

Please place the camera on a flat desktop to ensure the normal vertical and horizontal operation of the machine and the good cooling of the fan at the bottom

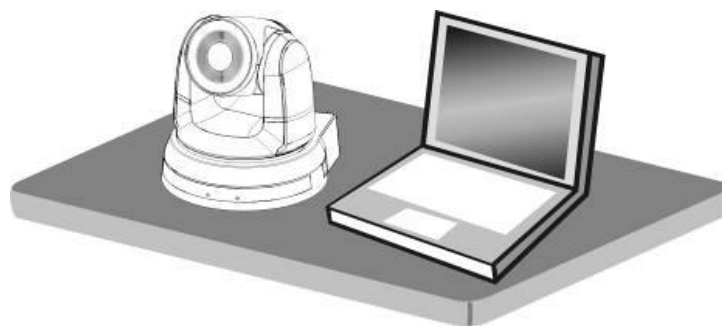

3.3.2 I would like to install the camera on the ceiling

3.3.2.1 Prepare for the parts and equipment required during the installation

- Accessories in the box (metal plates A, B, M3 screw silver x 8, black x 2)

- Screw for locking on ceiling mounted hanger x 4
- Drilling machine, screw driver, ladder

3.3.2.2 Metal Plate size diagram

- Metal plate A - machine side

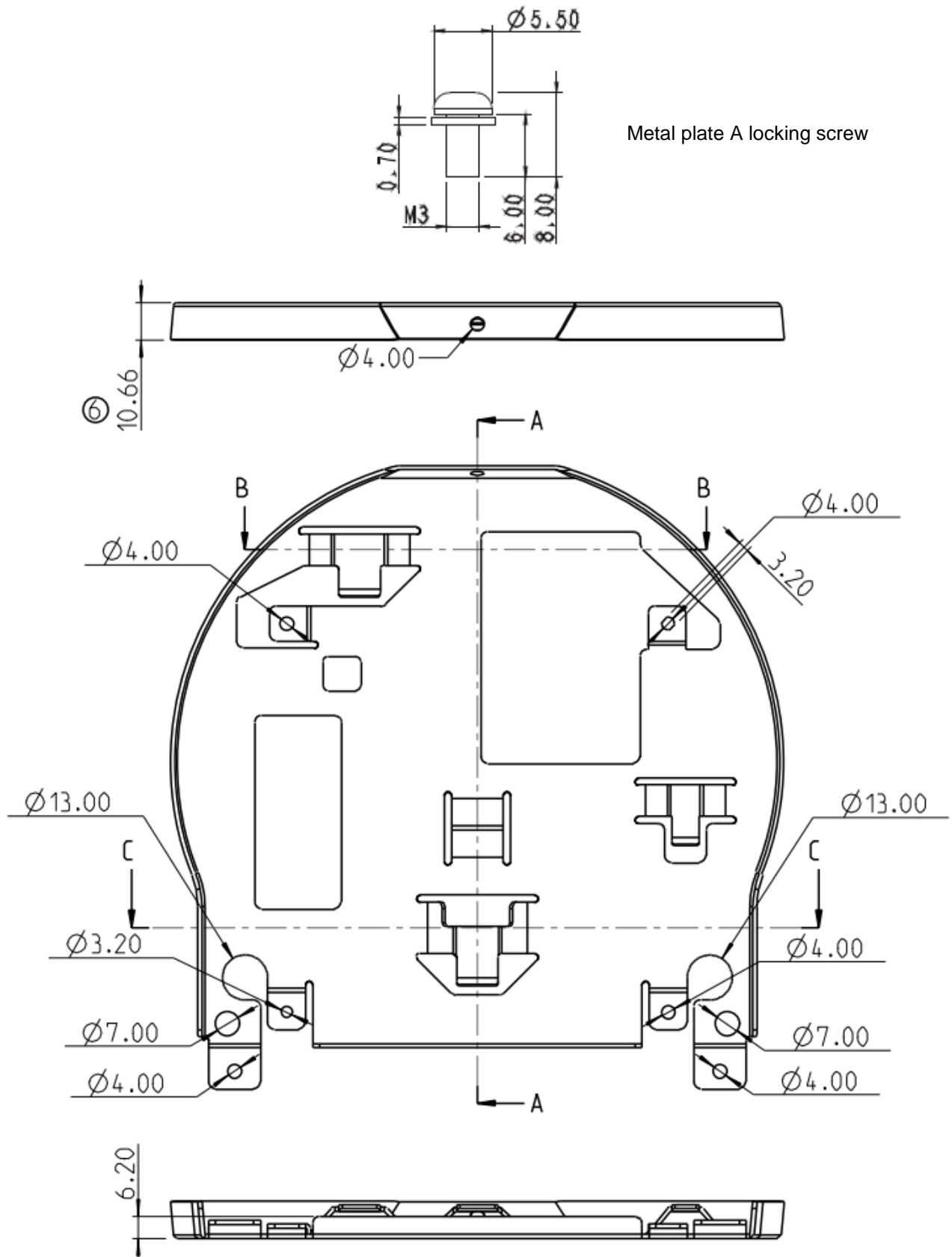

Metal plate A locking screw

Metal plate A - machine side

■ Metal plate B - ceiling side

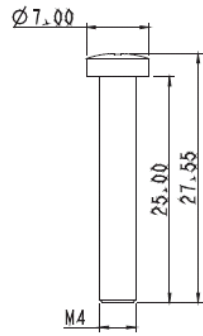

Metal plate B
locking screw

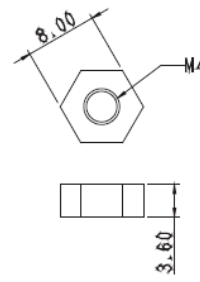

Metal plate B
locking bolt

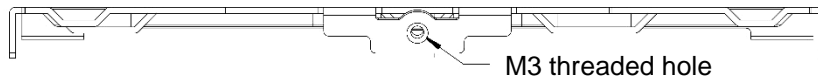

M3 threaded hole

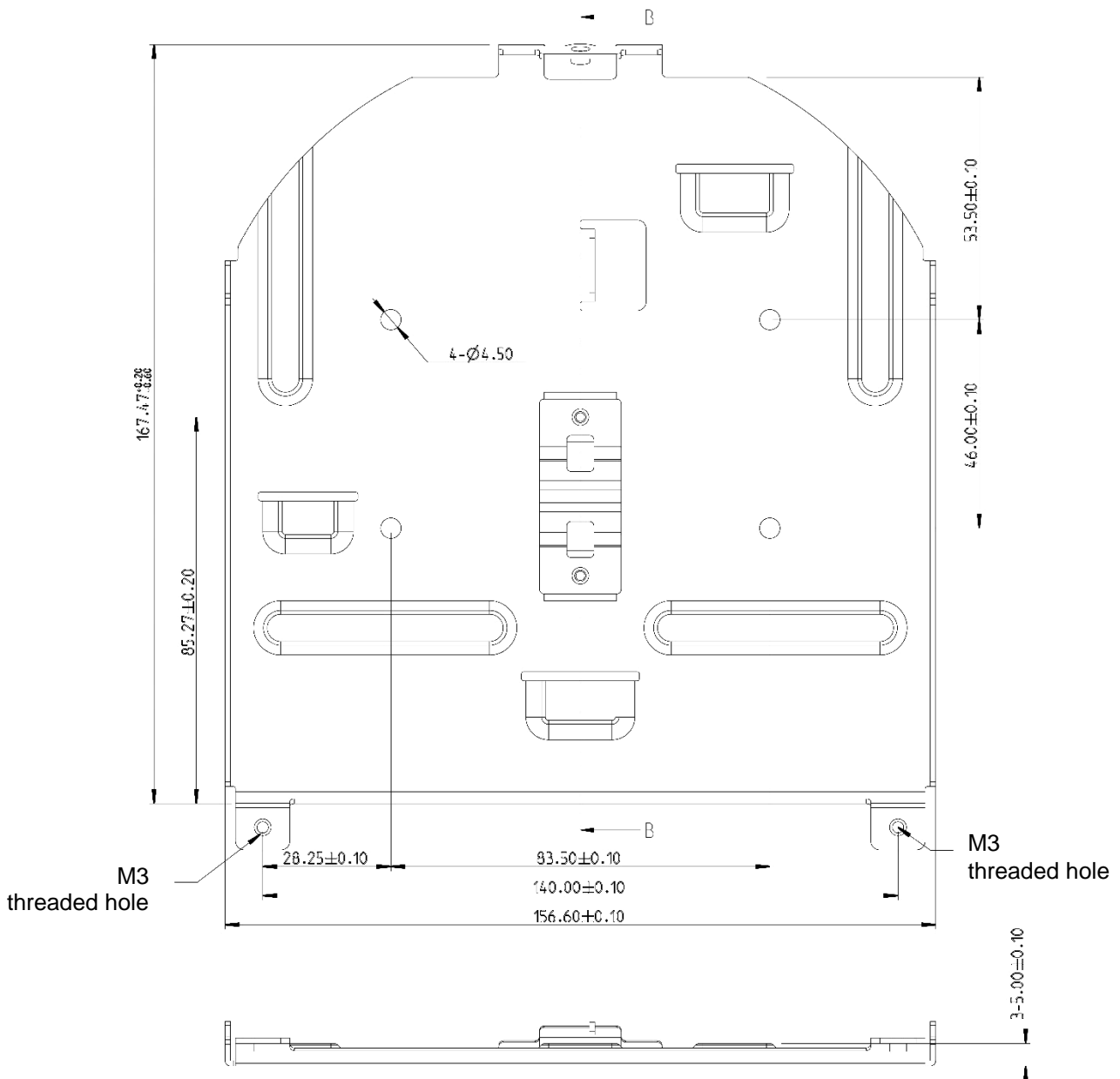

Metal plate B - ceiling side

3.3.2.3 Precautions for installation

1. Before installation, please confirm the orientation of the machine relative to the object to be captured
2. It is recommended that the machine should be set at a distance of more than 2 meter away from the object to be captured. Please adjust for a best distance according to the magnification of the lens

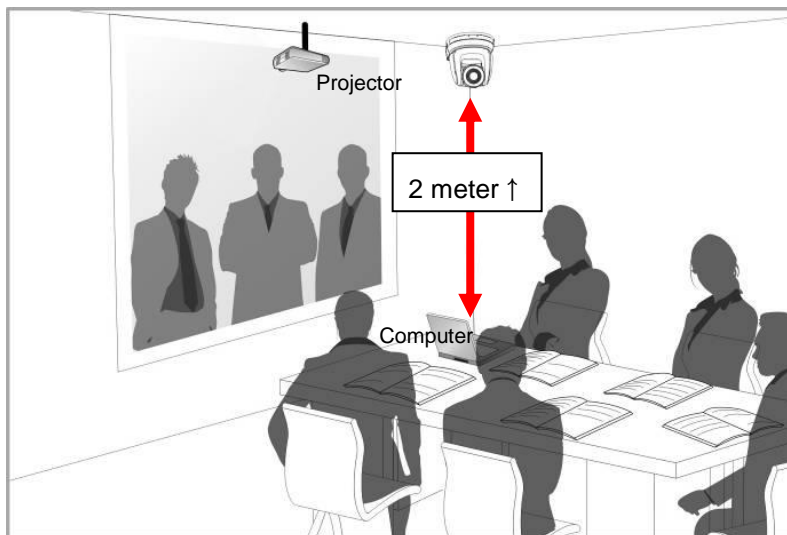

3. The machine (including metal plates) is weighed at about 4 kg. If it is to be installed on the ceiling, please use the hanger that has obtained UL security approval to prevent the machine from falling down.
4. Please check whether the camera is installed securely on a regular basis.
5. Please clean the cooling fan located at the bottom to ensure the good heat dissipation effect of the machine on a regular basis.

3.3.2.4 Installation steps

1. Remove the 4 foot pads on the machine base. The foot pads are designed to be detachable and can be removed by rotating them counterclockwise by hand.
<Remark> The removed foot pads must be kept properly for future use.

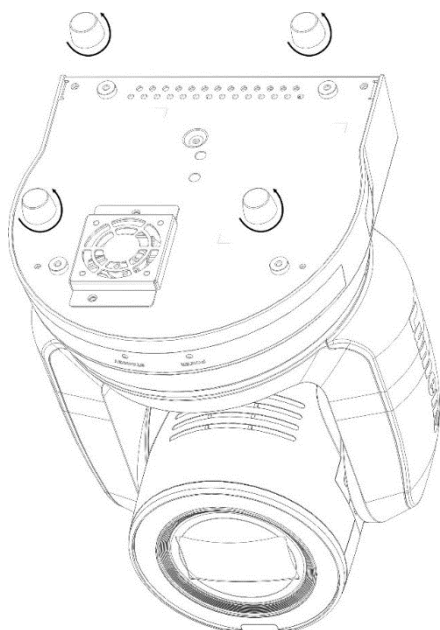

2. Fix the metal plate A on the machine base with 4 M3 silver screws

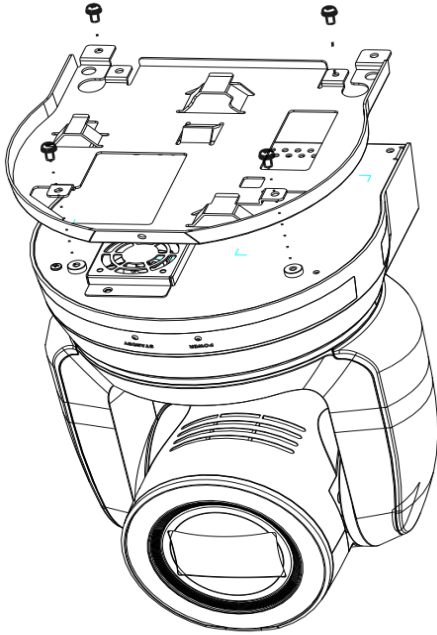

3. Lock the metal plate B on ceiling mounted hanger

<Note>

- (1) Please use the hanger that has obtained UL security approval
- (2) Please reserve the hole for the connecting wires of the camera

4. Combine the metal plate A and the metal plate B

- (1) Push the metal plate A up to the ceiling and then to the right to latch the metal plate B
- (2) And then secure with 2 M3 silver screws and 1 M3 black screw

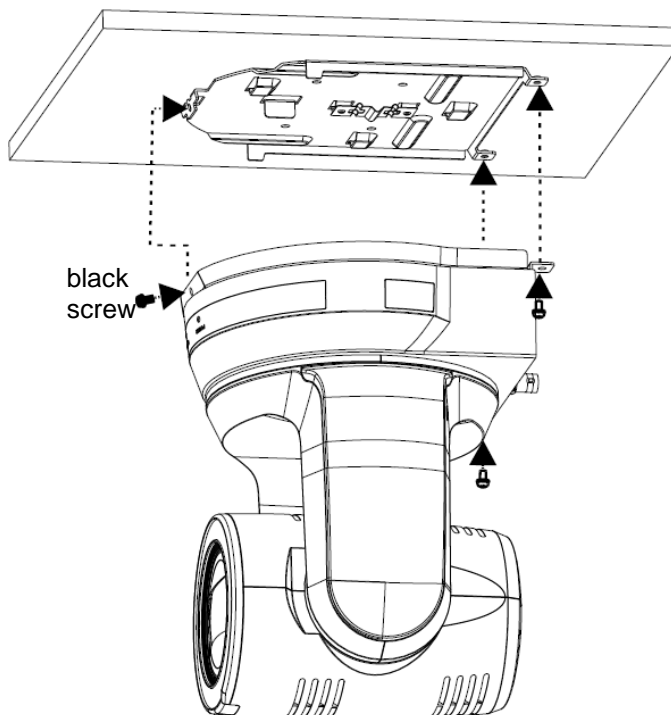

3.3.2.5 How to remove

1. Remove the connecting wires from the camera
2. Uninstall the camera together with the ceiling, loosen the three screws that fix the metal plates A and B and push to the left to remove the machine
3. Then remove the screws on the hanger and the machine

3.4 Connecting devices

3.4.1 RS-232 Connection

With RS-232 in/ out, at most 7 Lumens cameras can be connected.

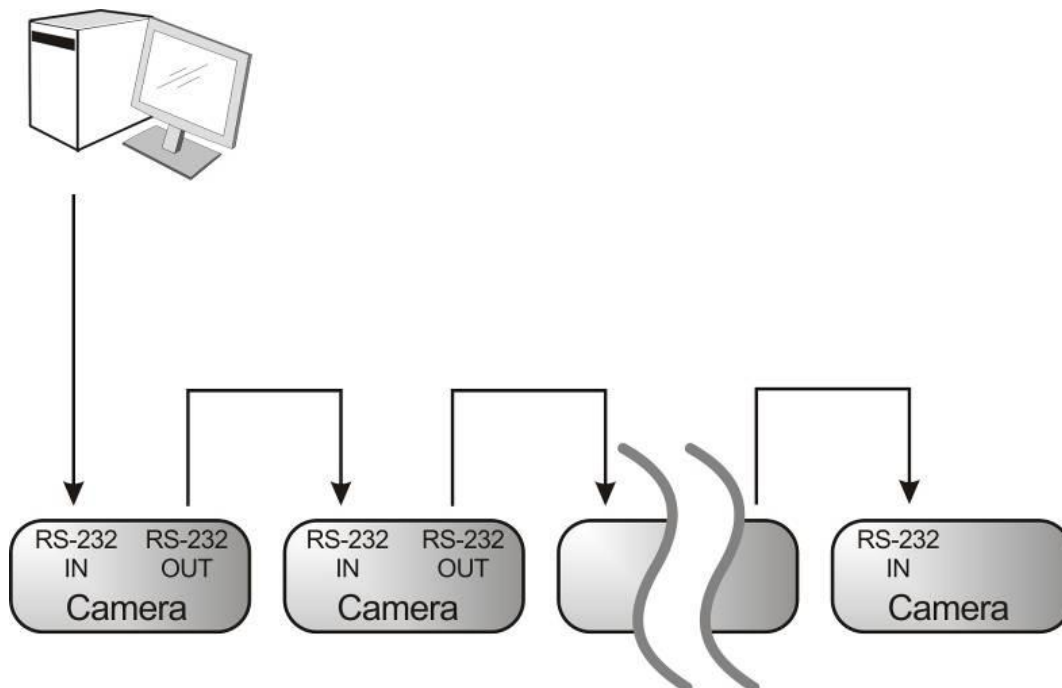

■ RS-232 pins definition instructions

▼ RS-232 IN Pins Instructions

NO	Pins	Signals
1	DTR	Data Transmission Reade
2	DSR	Data Set Reade
3	TXD	Transmit Data
4	GND	Ground
5	RXD	Receive Data
6	GND	Ground
7	IR OUT	IR Commander Signal
8	N.C.	No Connection

▼ RS-232 OUT Pins Instructions

NO	Pins	Signals
1	DTR	Data Transmission Reade
2	DSR	Data Set Reade
3	TXD	Transmit Data
4	GND	Ground
5	RXD	Receive Data
6	GND	Ground
7	OPEN	Reserved
8	OPEN	Reserved

▼ RS-232 Connection Instructions

RS-232 IN of VC	RS-232 of PC
1. DTR	1. CD
2. DSR	2. RXD
3. TXD	3. TXD
4. GND	4. DTR
5. RXD	5. GND
6. GND	6. DSR
7. IR OUT	7. RTS
8. N.C.	8. CTS
	9. RI

▼ RS-232 Connection Instructions

RS-232 IN of Next Camera	RS-232 OUT of Last Camera
1. DTR	1. DTR
2. DSR	2. DSR
3. TXD	3. TXD
4. GND	4. GND
5. RXD	5. RXD
6. GND	6. GND
7. IR OUT	7. OPEN
8. N.C.	8. OPEN

3.4.2 RS-422 Connection

With RS-422, at most 7 Lumens cameras can be connected.

<Note> When RS-422 connection is being used, do not use RS-232 connection.

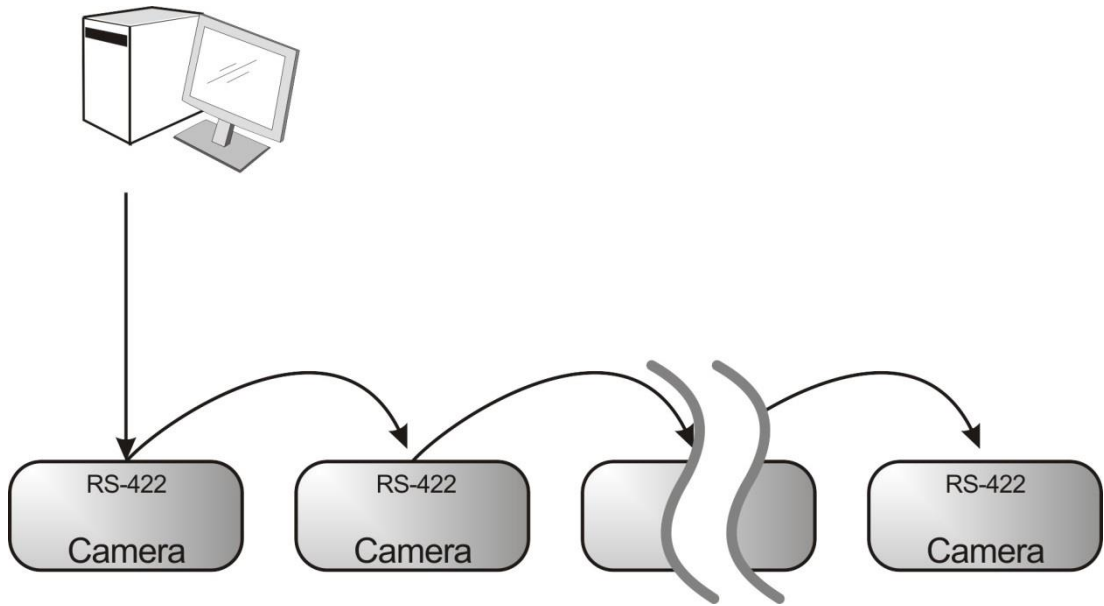

■ RS-422 pins definition instructions

▼ RS-422 Pins Instructions

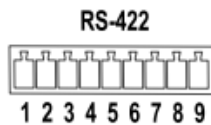

Pin NO.	Function
1	RXD OUT-
2	RXD OUT+
3	TXD OUT-
4	TXD OUT+
5	GND
6	RXD IN-
7	RXD IN+
8	TXD IN-
9	TXD IN+

▼ RS-422 Serial Connection

Up to seven cameras can be daisy-chained

⋮

Third Camera

1	RXD OUT-
2	RXD OUT+
3	TXD OUT-
4	TXD OUT+
5	GND
6	RXD IN-
7	RXD IN+
8	TXD IN-
9	TXD IN+

Second Camera

1	RXD OUT-
2	RXD OUT+
3	TXD OUT-
4	TXD OUT+
5	GND
6	RXD IN-
7	RXD IN+
8	TXD IN-
9	TXD IN+

First Camera

Compact Camera Controller

1	NC
2	NC
3	NC
4	NC
5	GND
6	RXD IN-
7	RXD IN+
8	TXD IN-
9	TXD IN+

1	RXD OUT-
2	RXD OUT+
3	TXD OUT-
4	TXD OUT+
5	GND
6	RXD IN-
7	RXD IN+
8	TXD IN-
9	TXD IN+

▼ RS-422 Connection Instructions

— Applicable to

Lumens Compact Camera Controller

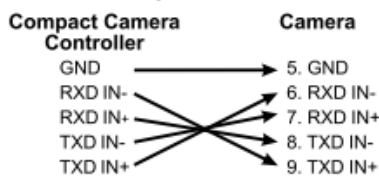

▼ RS-422 Connection Instructions

— Applicable to

SONY Compact Camera Controller

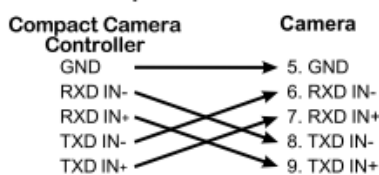

■ RS-422 connection instructions

1. Hold the two sides of RS-422 connector and pull out in the direction shown by the arrow in the figure below

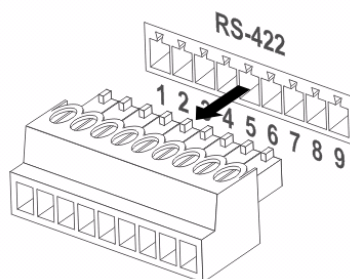

2. Peel off a section of copper wire (AWG Nos. 28 to 18) and insert it into the connector hole; then use flat screw driver to fix it

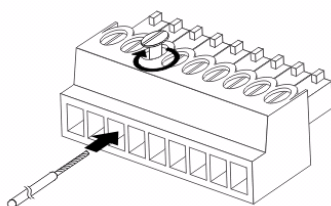

3. Insert the wired RS-422 connector back to the Camera. Now the connection is completed

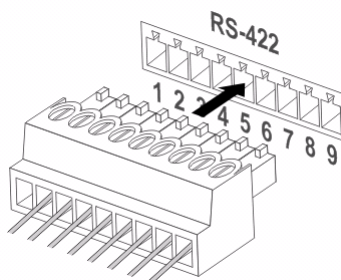

Chapter 4 Remote Control and Setting Menu

4.1 Functions of remote control

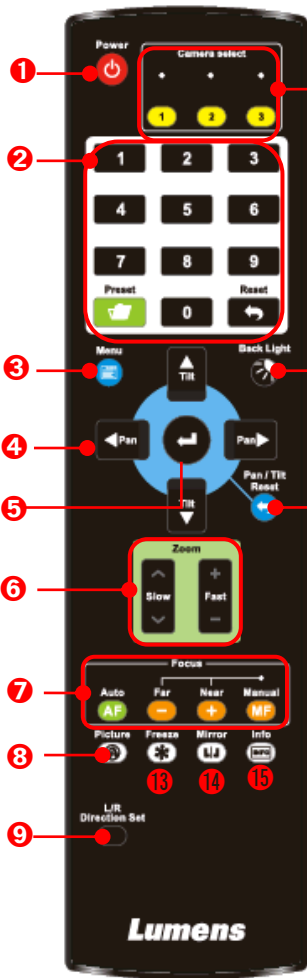

No.	Item	Description
1.	Power	Power Switch
2.	Preset	<ul style="list-style-type: none"> ■ Numeric Keys 0 - 9: Click to call the preset ■ Preset: Appoint an ID (0 ~ 9) to save the current position data ■ Reset: Appoint an ID (0 ~ 9) to delete the current position data
3.	Menu	Display OSD menu
4.	Pan/ Tilt	Move the lens
5.	Home-Enter	Go back to the main page/ Execute
6.	Zoom	<ul style="list-style-type: none"> ■ Fast: Adjust image size ■ Slow: Fine-tune image size
7.	Focus	<ul style="list-style-type: none"> ■ Auto: Auto focus ■ Manual: Enable Manual Focus ■ Far/ Near: Adjust the focal length in Manual
8.	Picture	Switch image effect (OFF/ Neg/ B&W)
9.	L/R Direction Set	L/R Direction / Normal
10.	Camera select	Choose Camera ID 1 ~ 3
11.	Back Light	Turn on/off back light compensation
12.	Pan/Tilt Reset	Clear the Pan/Tilt setting
13.	Freeze	Freeze the screen
14.	Mirror	Rotate the image (OFF/ Mirror/ Flip/ Rotate)
15.	Info	Status information

4.2 Setting Menu

<Remark> Press **[MENU]** on the **remote control** to enter the setting menu; the **bold underlined** values in the following table are defaults.

1st Level Major Items	2nd Level Minor Items	3rd Level Adjustment Values	Function Descriptions	
Exposure	Mode	1. Full Auto 2. Shutter Pri 3. Iris Pri 4. Manual	Exposure mode setting	
	Exposure Comp.	On/ Off	AE Level	
	Exposure Comp. Level	-5~ C ~5	The value can be adjusted after Exposure Comp. is activated	
	Spot Light	On/ Off		
	Spot Light Position	X(0~6)Y(0~4)	The value can be adjusted after Spot Light is activated	
	Shutter Pri	60/30 Mode	50/25 Mode	Adjustable when the Exposure mode is set to Shutter Pri
		1/10000-1/1		
	Iris Pri	F1.6~ C ~F18/ Off	Adjustable when the Exposure mode is set to Iris Pri	
	Manual Gain	0 -45dB	Adjustable when the Exposure mode is set to Manual	
	Manual Speed	60/30 Mode	50/25 Mode	Manually set the shutter
		1/10000-1/1		
	Manual Iris	F1.6~ C ~F18/ Off	Manually set the iris	
	Gain Limit	9- 45 dB	Max. limit value of electron gain	
	Iris Limit	F2.2 -F11	Max. limit value of iris	
WDR	Off / 1/ 2/			
Smart AE	On / Off	Available when "Focus - SMART AF" is on		
White Balance	Mode	1. Auto 2. In Door 3. Out Door 4. One Push WB 5. ATW 6. Manual B Gain 7. Sodium Lamp 8. 3000K 9. 4300K 10. 5000K 11. 6500K 12. 8000K	Select the color temperature mode 1. 4000k ~ 7000k 2. 3200k 3. 5800k 4. 1700k ~ 10000k 5. 1700k ~ 10000k 6. Custom 7. 2800k	
	One Push Trigger	ENTER	One push trigger	
	Manual Red	0~ C ~128	Adjustable when the white balance mode is set to Manual	
	Manual Blue	0~ C ~128	Adjustable when the white balance mode is set to Manual	
Picture	Picture effect	Off / Neg/ B&W		
	Sharpness	0~ C ~14		

1st Level Major Items	2nd Level Minor Items	3rd Level Adjustment Values	Function Descriptions
	2D NR	Off/ <u>1</u> / 2/ 3	
	3D NR	Off / LOW / <u>Typ</u> / Max	
	Image Mode	<u>Standard</u> / LED / Custom	The user may customize his/ her desired image mode
	Image Mode Load	<u>ENTER</u>	Adjustable when the <i>Image mode</i> is set to <i>Custom</i> . After selected, the corresponding <i>Image mode</i> parameters will be read and applied to <i>Custom</i>
	Brightness	0~ <u>C</u> ~15	Adjustable when the <i>Image mode</i> is set to <i>Custom</i>
	Hue	0~ <u>C</u> ~15	Adjustable when the <i>Image mode</i> is set to <i>Custom</i>
	Saturation	0~ <u>C</u> ~15	Adjustable when the <i>Image mode</i> is set to <i>Custom</i>
	Gamma	0~ <u>3</u>	Adjustable when the <i>Image mode</i> is set to <i>Custom</i>
Pan Tilt Zoom	Pan/Tilt Limit	On/ <u>Off</u>	Turn on/ off the angle limit setting
	Pan Right Limit	0~ <u>170</u>	Limit the right angle
	Pan Left Limit	<u>-170</u> ~0	Limit the left angle
	Tilt UP Limit	0~ <u>90</u>	Limit the upward angle
	Tilt Down Limit	<u>-30</u> ~0	Limit the downward angle
	Pan Flip	On/ <u>Off</u>	Activate the reverse Pan direction
	Tilt Flip	On/ <u>Off</u>	Activate the reverse Tilt direction
	Preset Speed	5/ 25/ 50/ 80/ 120/ <u>160</u> / 200/ 300 deg/sec	Set the PTZ rotation speed when Preset is performed
	Preset Mode	<u>Default</u> / PTZ Setting	<ul style="list-style-type: none"> ▪ Default: Call the preset, execute Pan/Tilt/Zoom/Focus + picture parameters setting ▪ PTZ Setting: Call the preset, only execute Pan/Tilt/Zoom/Focus
	PTZ Speed Comp	On/ <u>Off</u>	Set the Pan/Tilt moving speed to vary from the zoom position
	D-Zoom Limit	<u>x1</u> ~x12	Set the D-zoom limit <Remark> 3840 x 2160 59.94/ 50 does NOT support this setting
PTZ Motion Sync	On/ <u>Off</u>	When activated, PTZ synchronization can be achieved by controlling with the <i>Presets</i> <Remark> Refer to the Preset speed setting for this feature. The speed may be adjusted automatically due to the difference of PTZ moving range.	
D-Effect	Mirror	<u>On</u> / MIRROR/ Flip / MIRROR + Flip	Set the mode at which the image is mirror or flipped
Auto Focus	AF Sensitivity	LOW/ <u>MIDDLE</u> / HIGH	For AF triggering speed, the higher the speed is, the faster AF is triggered
	AF Frame	Center / Full Frame / <u>Auto</u>	AF frame setting, when central area was set as AF frame, focusing will be on the center of the screen. When Full Frame was set as AF frame, focusing will be calculated based on the full screen

1st Level Major Items	2nd Level Minor Items	3rd Level Adjustment Values	Function Descriptions
	Zoom Tracking	Manual/ <u>Curve Tracking</u> / Zoom Tracking	This function can be set in the Manual Focus (MF) mode Set the focus mode during lens zooming in Manual Focus mode
	PTZ Assist	On/ <u>Off</u>	This function can only be enabled in the Manual Focus (MF) mode When PTZ Assist is enabled and PTZ control is in operation, the focus performs only once upon immediate execution. The focus will not be triggered afterward when the scene changes
	SMART AF	On/ <u>Off</u>	Turn on this function and AF will mainly focus on the face
Ethernet	DHCP	<u>On</u> /Off	Enable/Disable DHCP setting using left and right arrow keys and press [ENTER] to apply setting.
	IP Address	<u>192.168.100.100</u>	Press [ENTER] to be in modify mode; select the item to be modified using the up and down keys, and modify the value using the left and right keys or the numeric keys.
	Subnet mask	<u>255.255.255.0</u>	Press [ENTER] to be in modify mode; select the item to be modified using the up and down keys, and modify the value using the left and right keys or the numeric keys.
	Gateway	<u>192.168.100.254</u>	Press [ENTER] to be in modify mode; select the item to be modified using the up and down keys, and modify the value using the left and right keys or the numeric keys.
Audio	Audio In	<u>Line In</u> /Mic In	Set Audio In
	Audio Enable	On/ <u>Off</u>	Turn on/off audio output
	Audio Volume	0~ <u>C</u> ~10	Audio Volume Setting
	Audio Delay	On/ <u>Off</u>	When the audio is not synchronized with the video, enable this function to set the audio delay time <Remark> Supported when NDI HX function setting is off
	Audio Delay Time(ms)	<u>-1</u> ~-500ms	Set audio delay time <Remark> Supported when NDI HX function setting is off
	Encode Type	<u>AAC</u> / G.711	Set audio encode type <Remark> Supported when NDI HX function setting is off
	Encode Sample Rate	1. 48 KHz(AAC) 2. 44.1 KHz(AAC) 3. 16 KHz(AAC) 4. 16 KHz(G.711) 5. 8 KHz(G.711)	Set the encode type and sample rate <Remark> Supported when NDI HX function setting is off
System	Prompt	On/ <u>Off</u>	Turn on/off the prompt information on the display
	IR Receive	<u>On</u> /Off	When it is Off, the remote control will not be able to control the camera. At this moment, turn off and then turn on the power to restore control of the remote control.

1st Level Major Items	2nd Level Minor Items	3rd Level Adjustment Values	Function Descriptions
	Tally Lamp	On/ <u>Off</u>	Select to enable or disable Tally Lamp function.
	Tally CMMD Mode	Normal/ <u>Link</u>	Set whether the indicator is linked with RS232 command <ul style="list-style-type: none"> ▪ Normal (Not linked): The indicator light status and mode shall be set separately. <ul style="list-style-type: none"> · When the indicator light is on and the default mode is off, additional command is required to set the indicator light mode · Setting indicator light mode when the indicator light is off will not trigger the indicator light ▪ Link: <ul style="list-style-type: none"> · When the indicator light is on, the default mode is red light · Setting indicator light mode when the indicator light is off will turn on the indicator light
	Language	<u>English</u> / 中文	
	Initial Position	<u>Last MEM</u> / 1st Preset	Select the camera lens to return to the last operated position or the first preset position after POWER ON <Remark> 1st Preset = Preset 0
	Control Device	Encoder / <u>Controller</u>	Control Device setting, Controller: for joystick Encoder: for tracking system
	Motionless Preset	On/ <u>Off</u>	When the function is enabled, the screen will Freeze when Preset is executed. Freeze will be released after Preset is completed.
	Control Port	<u>RS-232</u> /RS-422	Choose whether the control interface used is RS-232 or RS-422
	Protocol	<u>VISCA</u> / Pelco D	
	Baud Rate	<u>9600</u> /38400	Choose the transmission speed of the control signal
	VISCA Address	<u>0</u> ~7	The Protocol set to VISCA allows the camera ID address to be assigned. Select 0 for automation.
	PELCO D Address	<u>1</u> ~255	The Protocol set to Pelco D allows the camera ID address to be assigned.
	Output Mode	1. <u>3840x2160/59.94p</u> 2. 3840x2160/50p 3. 3840x2160/29.97p 4. 3840x2160/25p 5. 1080p/59.94 6. 1080p/50 7. 1080p/29.97 8. 1080p/25 9. 720p/59.94 10. 720p/50 11. 1080i/59.94 12. 1080i/50	Choose the output resolution
	Color Space	<u>Standard Profile</u> / REC.709 / BT.2020	Set the standard for color gamut
	Factory Reset	On/ <u>Off</u>	Resume the factory default setting
Status			Display the current setting status

Chapter 5 Network Function Settings Description

5.1 Connecting Camera to Network

5.1.1 Connecting to Internet

Two common connection methods are shown below

1. Connecting via switch or router

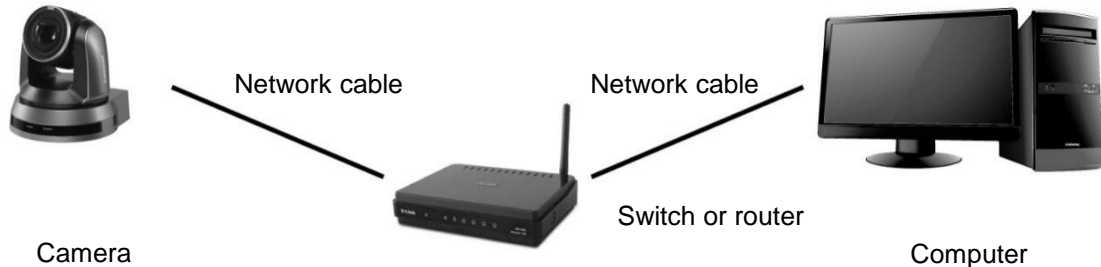

2. To connect directly through network cable, the IP address of the computer should be changed so that it is on the same network segment as the camera

E.g.: The factory-preset default IP address of the camera is 192.168.100.100. The computer IP address must be set with the same network segment, such as 192.168.100.101, so that the computer can be connected correctly with the camera

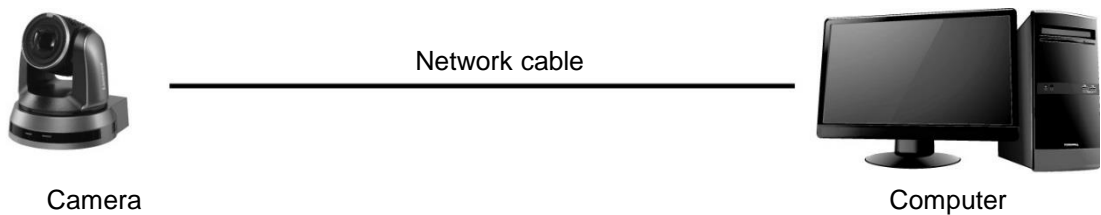

- Change network settings

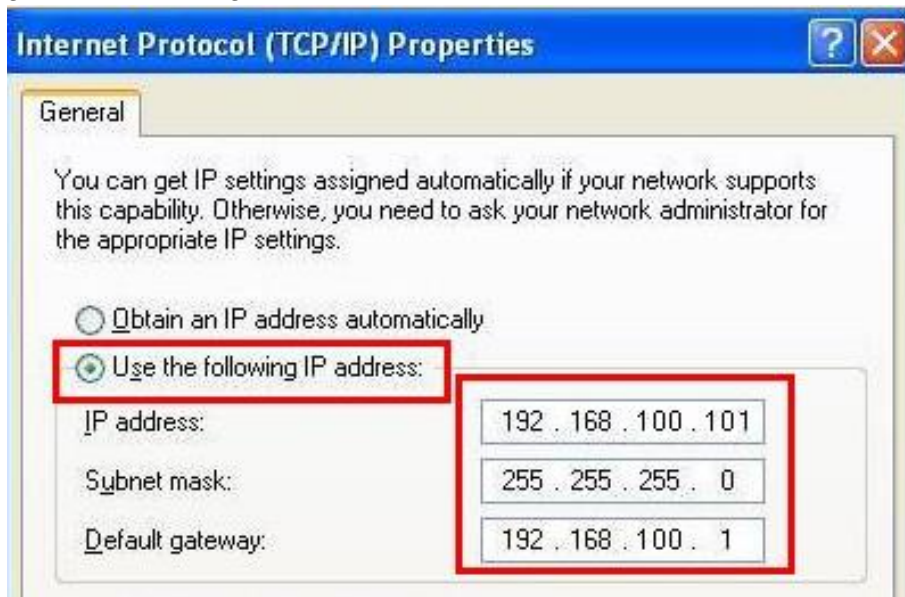

5.1.2 Using the Browser to View the Images

- Open the browser, and enter the IP address of the camera in the address bar
E.g.: [http:// 192.168.100.100](http://192.168.100.100) (Default IP address)
- Enter administrator's account and password
For a first-time login, please refer to [5.2.3 Account Management](#) to change the default password



Lumens Network Camera
● Account: admin
● Password: 9999 (Default)

5.1.3 Using RTSP Player to View the Images

<Remark> Supported when NDI|HX function is off (Please refer to [5.2.5 Setting - Video - NDI|HX](#))
In addition to the browser and VMS, other free softwares also can be used for RTSP connection, such as VLC, Quick Time and PotPlayer
RTSP connection address formats are as follows:

- RTSP Streaming 1 (4K@H.265) => [rtsp:// camera IP: 8554/ hevc](rtsp://camera IP: 8554/ hevc)
- RTSP Streaming 2 (1080P@H.264) => <rtsp:// camera IP: 8557/ h264>
- RTSP Streaming 3 (720P@H.264) => <rtsp:// camera IP: 8556/ h264>

If password authentication is enabled, the RTSP connection address is as follows:

- RTSP Streaming 1
<rtsp://Username:Password@VC IP address:port/hevc>
- RTSP Streaming 2/ 3
<rtsp://Username:Password@VC IP address:port/h264>
- To enable password authentication function, please refer to [5.2.9 Setting - Network](#)

Example:

Open the VLC software, click [Open Network Streaming], and enter the URL:
[rtsp:// 192.168.100.100:8554/ hevc](rtsp://192.168.100.100:8554/hevc)

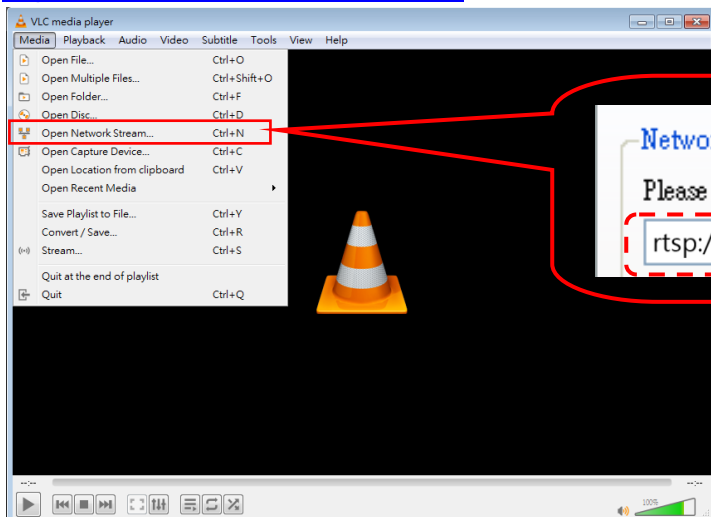

5.1.4 Using NDI Studio Monitor to View the Images

<Remark> Supported when NDI|HX function is on (Please refer to [5.2.5 Setting - Video - NDI|HX](#))
For the NDI|HX operation, please download the latest NDI software from the NewTek website
[https:// www.newtek.com/](https://www.newtek.com/)

5.2 Web Page Function Description

5.2.1 Login Screen



No	Item	Function Descriptions
1	Username	Please enter user account (Default: admin)
2	Password	Please enter user password (Default: 9999) <Remark> For a first-time login, please refer to 5.2.3 Account Management to change the default password
3	Language selection	Currently, the system supports English, Traditional Chinese and Simplified Chinese
4	Remember Password	Save user account name and password to the browser. When you log in next time, there is no need to re-enter them
5	Login	Log into the administrator screen on the website

5.2.2 Viewing In Real Time

<Remark> Preview pane is not supported when NDI is on

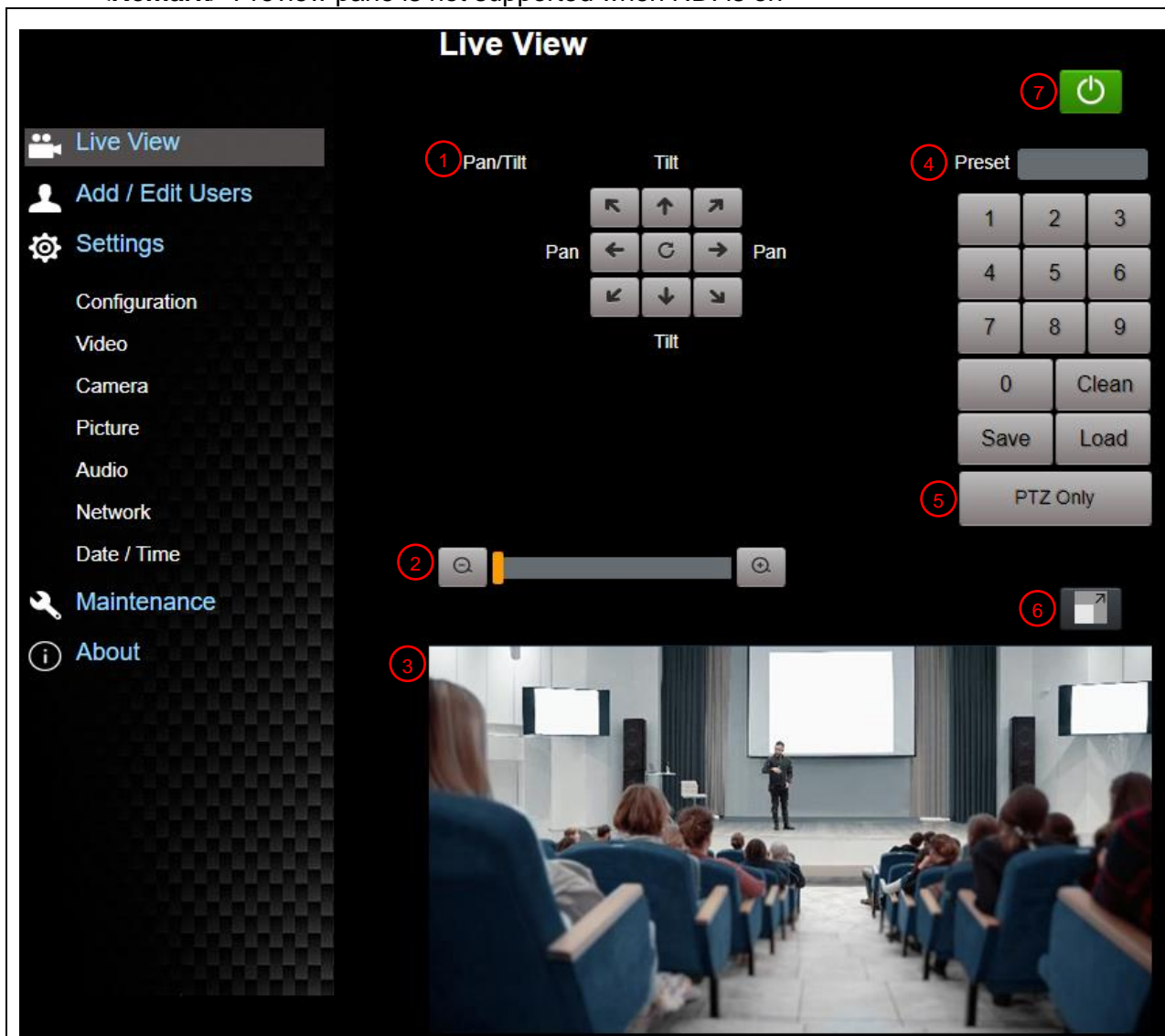

No	Item	Function Descriptions	NDI ON	NDI OFF
1	Pan/Tilt setting	Adjust the Pan/Tilt position of the camera screen	V	V
2	Zoom ratio	Adjust the zoom-in or zoom-out ratio via scroll bar	V	V
3	Preview window	Display the screen currently captured by the camera		V
4	Preset setting	Select the number first and then select SAVE or LOAD	V	V
5	PTZ Only	Enable/disable PTZ Only <ul style="list-style-type: none"> ▪ Disable (Default): Call the preset, execute Pan/Tilt/Zoom/Focus + picture parameters setting ▪ Enable: Call the preset, only execute Pan/Tilt/Zoom/Focus 	V	V
6	Switch to Full Screen	Switch the preview window to full screen		V
7	Power button	Turn on or turn off the camera power	V	V

5.2.3 Account Management

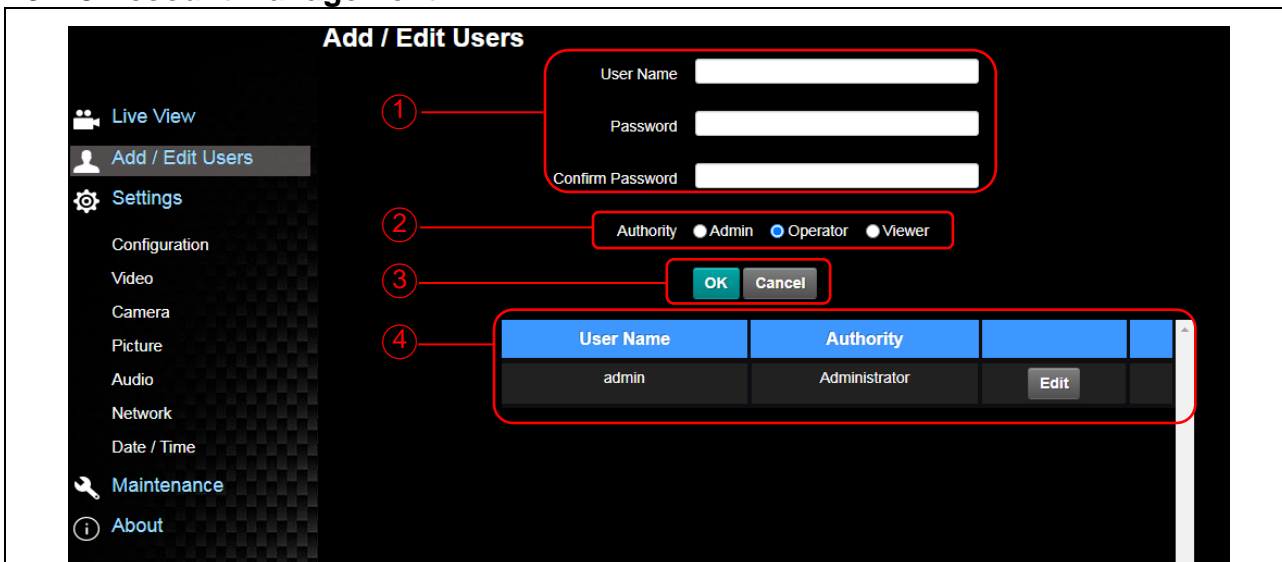

No	Item	Function Descriptions																
1	Add user account	Enter a user name and password to add a new user																
2	Permission setting	Set the new account management permissions <table border="1" style="margin-left: 20px;"> <thead> <tr> <th>User Type</th> <th>Admin</th> <th>Operator</th> <th>Viewer</th> </tr> </thead> <tbody> <tr> <td>View images</td> <td>V</td> <td>V</td> <td>V</td> </tr> <tr> <td>Settings</td> <td>V</td> <td>V</td> <td>X</td> </tr> <tr> <td>Account management</td> <td>V</td> <td>X</td> <td>X</td> </tr> </tbody> </table>	User Type	Admin	Operator	Viewer	View images	V	V	V	Settings	V	V	X	Account management	V	X	X
User Type	Admin	Operator	Viewer															
View images	V	V	V															
Settings	V	V	X															
Account management	V	X	X															
3	Applying setting	Add the newly created user to the list of account																
4	List of accounts	Edit: Modify the user password and permissions Delete: Delete the user account																

5.2.4 Setting - System Setting

<Remark> Preview pane is not supported when NDI is on

No	Item	Function Descriptions
1	Resolution	Set the resolution of the camera, resolutions supported by the camera are as follows: 3840x2160 59.94 / 50 / 29.97 / 25 fps 1080p 59.94 / 50 / 29.97 / 25 720p 59.94 / 50 1080i 59.94/ 50 <Remark> After switching to the resolution, the camera will restart. Please refresh the browser
2	Output Source	According to the output resolution, you can select HDMI+NDI, HDMI + Streaming or HDMI + UVC output <Remark> When it is set to UVC output, 3840 x 2160 30p or lower resolutions are supported HDMI+NDI is supported when NDI is on HDMI + Streaming is supported when NDI is off
3	HDMI Format	Select YUV422 / YUV420 / RGB <Remark> When it is set to YUV420, 3840 x 2160 60p/ 59.94p/ 50p resolutions are supported
4	Color Space	Set the standard for color gamut Standard Profile/ REC.709/ BT.2020
5	Overlay	Set the stream to display “date and time” or “custom content” and to display location
6	Apply	After the setting has been modified, select this button to apply the setting

5.2.5 Setting - Video

<Remark> Preview pane is not supported when NDI is on

NDI OFF

NDI ON

No	Item	Function Descriptions	NDI ON	NI OFF
1	Camera ID	<p>Modify the camera name</p> <ul style="list-style-type: none"> Camera names are limited to 1 - 12 characters Please mix uppercase and lowercase letters or numbers for characters. Special symbols such as “/” and “space” cannot be used <p><Remark> Modifying this field will modify the Onvif device name synchronously</p>	V	V
2	Location	Modify the location of the camera, such as Room1	V	V

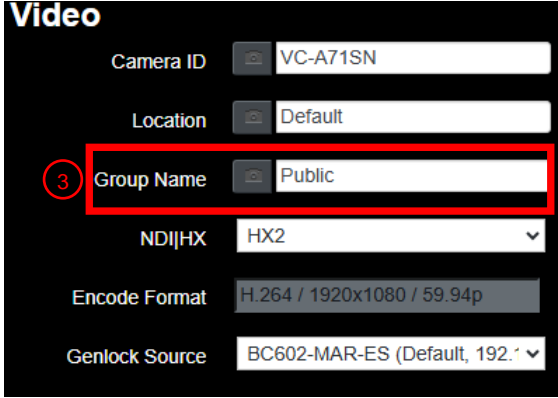
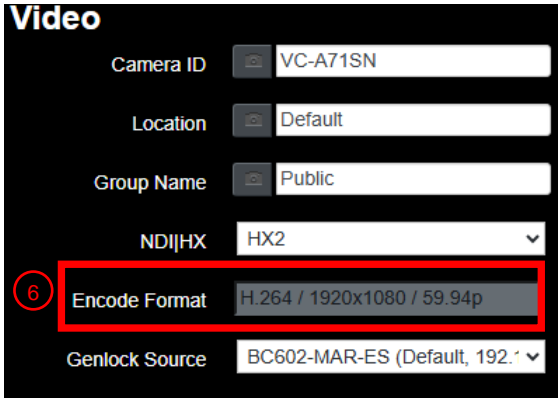
		<ul style="list-style-type: none"> Camera location is limited to 1-11 characters Please mix uppercase and lowercase letters or numbers for characters. Special symbols such as “/” and “space” cannot be used <p><Remark> Modifying this field will modify the Onvif device location synchronously</p>		
3	Group Name	 <p>The group name can be modified here and set with Access Manager - Receive in NDI Tool</p> <ul style="list-style-type: none"> If no group is assigned, the machine belongs to Public. As the default of Access Manager includes Public, Studio Monitor can discover this machine If a group is assigned, but this group is not added into Access Manager, Studio Monitor cannot discover this machine If a group is assigned and this group is added into Access Manager, Studio Monitor can discover this machine <p>The name can contain commas (,) to distinguish different groups Example: default, 123, abc means this machine belongs to three groups at the same time (default/ 123/ abc)</p>	V	
4	NDI HX	<p>Set NDI HX 2/ HX3/ Off</p> <ul style="list-style-type: none"> NDI HX 2/ HX3: Support NDI (ONVIF cannot find devices, and RTSP/ RTMP/ RTMPS/ MPEG-TS/ SRT streams cannot be used.) Off: Support RTSP/ RTMP/ RTMPS/ MPEG-TS/ SRT, and ONVIF can find devices but cannot be used with NDI Tool 	V	V
5	Streaming 1 / 2 / 3	<p>This can be seen when 5.2.4 Settings - System Settings - Output Signals is set to HDMI + Streaming</p> <p>Turn on streaming function. VC-A71SN supports 3 streaming outputs. Please refer to Streaming Parameter Setting table below for relevant settings</p>		V
6	Encode Format	<p>Display the Encode information.</p> 	V	
7	UVC	<p>This can be seen when 5.2.4 Settings - System Settings - Output Signals is set to HDMI + UVC</p>	V	V

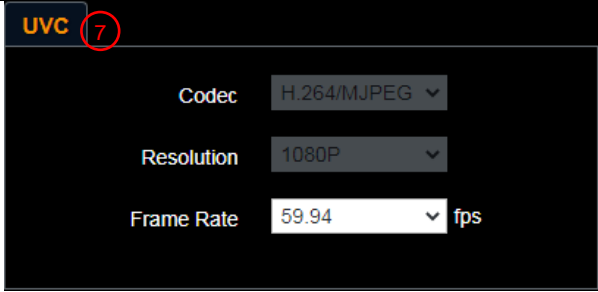
		 <ul style="list-style-type: none"> ▪ Encode Format: <ul style="list-style-type: none"> ➤ 3840x2160 29.97 / 25 fps: H.264 ➤ Less than 1080p (inclusive): H.264/ MJPEG ▪ Resolution: It is shown based on 5.2.4 Settings - System Settings – Resolution ▪ Frame Rate: 3840 x 2160 can only select the highest 29.97 fps 		
8	Apply	After the setting has been modified, select this button to apply the setting	V	V

▪ Streaming parameter setting

Function		Streaming 1	Streaming 2	Streaming 3
Encode Format		H.265	H.264	
Resolution		4K /1080P / 720P	1080P / 720P/ 1080i	640x360
Frame Rate		Setting according to the supported resolution		
Bit Rate(kbps)	Range	2,000~20,000	2,000~20,000	512~5,000
	Factory Default	15,000	7,500	1,000
Rate Control		CBR / VBR		
IP Ratio		Setting according to the supported resolution		

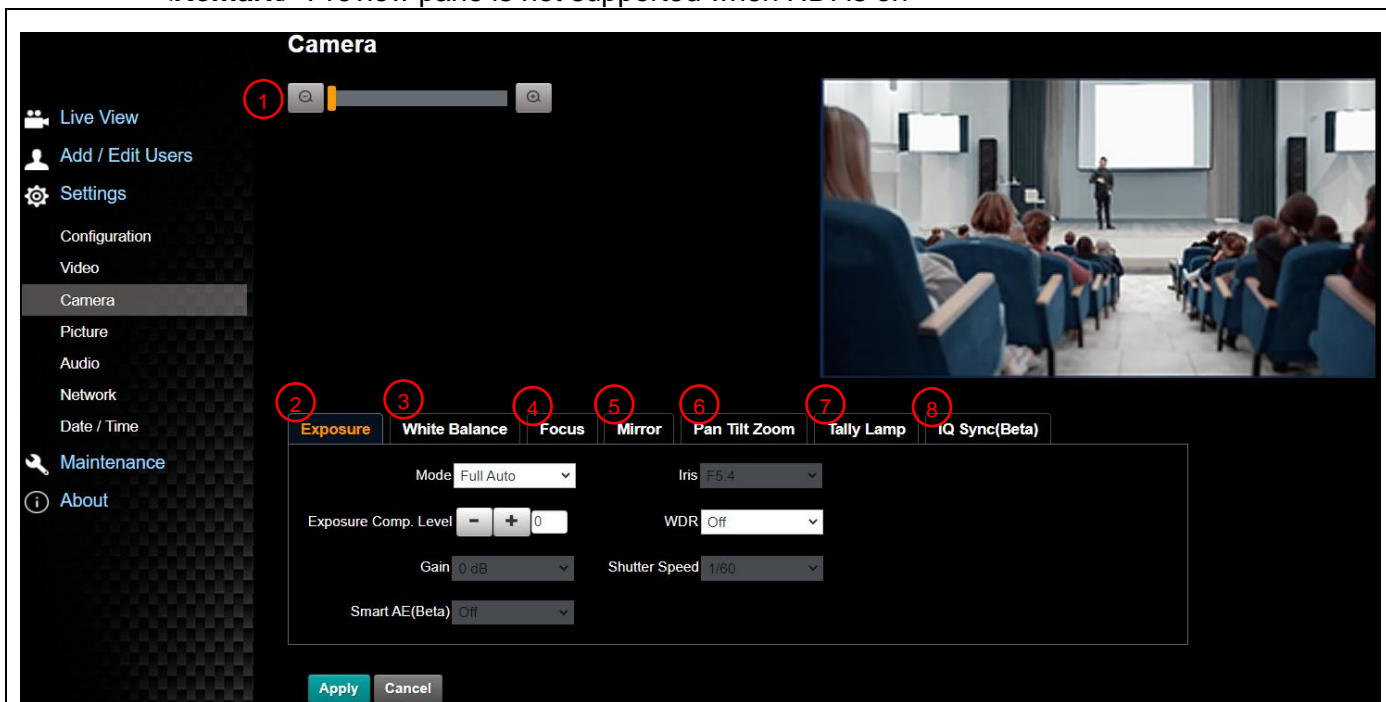

5.2.6 Setting - Camera

<Remark> Preview pane is not supported when NDI is on

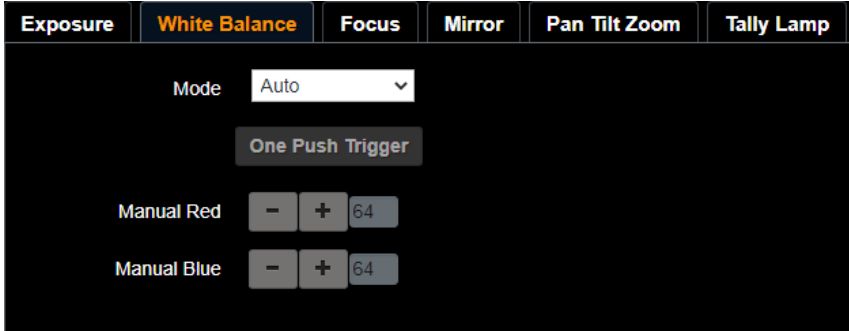

No	Item	Function Descriptions
1	Zoom ratio	Adjust the zoom-in or zoom-out ratio via scroll bar
2	Exposure	<ul style="list-style-type: none"> ■ Mode: Select exposure mode (Automatic/ Shutter Priority/ Aperture Priority/ Manual) ■ Exposure Comp. Level: Select exposure compensation level ■ Gain: The gain limit is adjustable when the exposure mode is set to “Manual” ■ Iris: The size of aperture is adjustable when the exposure mode is set to “Manual” or “Aperture Priority” ■ WDR: Set the level of wide dynamic range (WDR) in order to obtain better images ■ Shutter Speed: The shutter speed is adjustable when the exposure mode is set to “Manual” or “Shutter Priority” ■ Smart AE: Enable/Disable Smart Exposure; Available when “Focus - SMART AF” is on (Currently it’s the bet version. Please refer to Web Page Firmware Update Information for the official version release schedule.)
3	White Balance	 <ul style="list-style-type: none"> ■ Mode: Select the color temperature mode ■ One Push Trigger: One push color temperature is adjustable when the white balance mode is set to “One Push Trigger” ■ Manual Red / Blue: Manually adjust blue/red color temperature

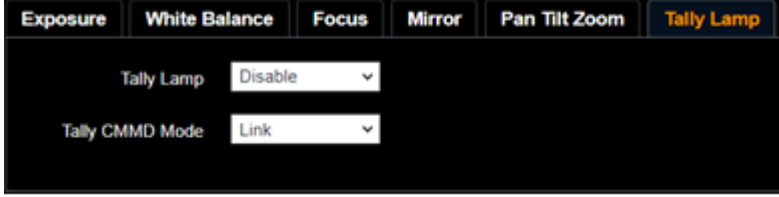
4	Focus	<table border="1"> <thead> <tr> <th>Exposure</th> <th>White Balance</th> <th>Focus</th> <th>Mirror</th> <th>Pan Tilt Zoom</th> <th>Tally Lamp</th> <th>IQ Sync</th> </tr> </thead> <tbody> <tr> <td colspan="7"> <div style="background-color: #1a1a1a; color: white; padding: 10px;"> <p>Mode <input type="text" value="Auto"/></p> <p>Focus Range <input type="text" value="27"/></p> <p>AF Sensitivity <input type="text" value="Middle"/></p> <p>AF Frame <input type="text" value="Auto"/></p> <p>Zoom Tracking <input type="text" value="Curve Tracking"/></p> <p>PTZ Assist <input type="text" value="Off"/></p> <p>Smart AF <input type="text" value="On"/></p> <p>Preset AF <input type="text" value="On"/></p> <p><input type="button" value="One Push AF"/></p> </div> <ul style="list-style-type: none"> ■ Mode: Select manual/automatic focus ■ Focus Range: The focusing range is adjustable when the focus mode is set to "Manual" ■ AF Sensitivity: Set automatic focus sensitivity ■ AF Frame: Set automatic focus range ■ Zoom Tracking: Set the focus mode during lens zooming in Manual Focus mode ■ PTZ Assist: In Manual, check whether auto focus is enabled if there is any changes of PTZ ■ Smart AF: Turn on this function and AF will mainly focus on the face ■ One Push AF: When the manual focus mode is on, click the button to perform one auto focus </td> </tr> </tbody> </table>	Exposure	White Balance	Focus	Mirror	Pan Tilt Zoom	Tally Lamp	IQ Sync	<div style="background-color: #1a1a1a; color: white; padding: 10px;"> <p>Mode <input type="text" value="Auto"/></p> <p>Focus Range <input type="text" value="27"/></p> <p>AF Sensitivity <input type="text" value="Middle"/></p> <p>AF Frame <input type="text" value="Auto"/></p> <p>Zoom Tracking <input type="text" value="Curve Tracking"/></p> <p>PTZ Assist <input type="text" value="Off"/></p> <p>Smart AF <input type="text" value="On"/></p> <p>Preset AF <input type="text" value="On"/></p> <p><input type="button" value="One Push AF"/></p> </div> <ul style="list-style-type: none"> ■ Mode: Select manual/automatic focus ■ Focus Range: The focusing range is adjustable when the focus mode is set to "Manual" ■ AF Sensitivity: Set automatic focus sensitivity ■ AF Frame: Set automatic focus range ■ Zoom Tracking: Set the focus mode during lens zooming in Manual Focus mode ■ PTZ Assist: In Manual, check whether auto focus is enabled if there is any changes of PTZ ■ Smart AF: Turn on this function and AF will mainly focus on the face ■ One Push AF: When the manual focus mode is on, click the button to perform one auto focus 						
Exposure	White Balance	Focus	Mirror	Pan Tilt Zoom	Tally Lamp	IQ Sync										
<div style="background-color: #1a1a1a; color: white; padding: 10px;"> <p>Mode <input type="text" value="Auto"/></p> <p>Focus Range <input type="text" value="27"/></p> <p>AF Sensitivity <input type="text" value="Middle"/></p> <p>AF Frame <input type="text" value="Auto"/></p> <p>Zoom Tracking <input type="text" value="Curve Tracking"/></p> <p>PTZ Assist <input type="text" value="Off"/></p> <p>Smart AF <input type="text" value="On"/></p> <p>Preset AF <input type="text" value="On"/></p> <p><input type="button" value="One Push AF"/></p> </div> <ul style="list-style-type: none"> ■ Mode: Select manual/automatic focus ■ Focus Range: The focusing range is adjustable when the focus mode is set to "Manual" ■ AF Sensitivity: Set automatic focus sensitivity ■ AF Frame: Set automatic focus range ■ Zoom Tracking: Set the focus mode during lens zooming in Manual Focus mode ■ PTZ Assist: In Manual, check whether auto focus is enabled if there is any changes of PTZ ■ Smart AF: Turn on this function and AF will mainly focus on the face ■ One Push AF: When the manual focus mode is on, click the button to perform one auto focus 																
5	Mirror	<table border="1"> <thead> <tr> <th>Exposure</th> <th>White Balance</th> <th>Focus</th> <th>Mirror</th> <th>Pan Tilt Zoom</th> <th>Tally Lamp</th> <th>IQ Sync</th> </tr> </thead> <tbody> <tr> <td colspan="7"> <div style="background-color: #1a1a1a; color: white; padding: 10px;"> <p>Mirror <input type="text" value="Off"/></p> </div> <ul style="list-style-type: none"> ■ Mirror: Set automatic flip mode [Off/ Mirror/ Flip/ Mirror + Flip] </td> </tr> </tbody> </table>	Exposure	White Balance	Focus	Mirror	Pan Tilt Zoom	Tally Lamp	IQ Sync	<div style="background-color: #1a1a1a; color: white; padding: 10px;"> <p>Mirror <input type="text" value="Off"/></p> </div> <ul style="list-style-type: none"> ■ Mirror: Set automatic flip mode [Off/ Mirror/ Flip/ Mirror + Flip] 						
Exposure	White Balance	Focus	Mirror	Pan Tilt Zoom	Tally Lamp	IQ Sync										
<div style="background-color: #1a1a1a; color: white; padding: 10px;"> <p>Mirror <input type="text" value="Off"/></p> </div> <ul style="list-style-type: none"> ■ Mirror: Set automatic flip mode [Off/ Mirror/ Flip/ Mirror + Flip] 																
6	Pan Tilt Zoom	<table border="1"> <thead> <tr> <th>Exposure</th> <th>White Balance</th> <th>Focus</th> <th>Mirror</th> <th>Pan Tilt Zoom</th> <th>Tally Lamp</th> <th>IQ Sync</th> </tr> </thead> <tbody> <tr> <td colspan="7"> <div style="background-color: #1a1a1a; color: white; padding: 10px;"> <p>Pan/Tilt Limit <input type="text" value="Off"/></p> <p>Pan Right Limit <input type="text" value="170"/></p> <p>Pan Left Limit <input type="text" value="-170"/></p> <p>Tilt Up Limit <input type="text" value="90"/></p> <p>Tilt Down Limit <input type="text" value="-30"/></p> <p>Pan Flip <input type="text" value="Off"/></p> <p>Tilt Flip <input type="text" value="Off"/></p> <p>Preset Speed <input type="text" value="160 deg/sec"/></p> <p>PTZ Speed Comp <input type="text" value="Off"/></p> <p>Initial Position <input type="text" value="Last MEM"/></p> <p>Motionless Preset <input type="text" value="Off"/></p> <p>D-Zoom Limit <input type="text" value="x1"/></p> <p>PTZ Motion Sync <input type="text" value="Off"/></p> </div> <ul style="list-style-type: none"> ■ Pan/Tilt limit: Set the pan/tilt limit ■ Pan/Tilt flip: Set Pan/Tilt flip ■ Preset Speed: Set the rotation speed of the cradle head when Preset is executed ■ PTZ Speed Comp: Set the Pan/Tilt moving speed to vary from the zoom position ■ Initial Position: Set the camera lens to return to the last operated position or the first preset position after POWER ON </td> </tr> </tbody> </table>	Exposure	White Balance	Focus	Mirror	Pan Tilt Zoom	Tally Lamp	IQ Sync	<div style="background-color: #1a1a1a; color: white; padding: 10px;"> <p>Pan/Tilt Limit <input type="text" value="Off"/></p> <p>Pan Right Limit <input type="text" value="170"/></p> <p>Pan Left Limit <input type="text" value="-170"/></p> <p>Tilt Up Limit <input type="text" value="90"/></p> <p>Tilt Down Limit <input type="text" value="-30"/></p> <p>Pan Flip <input type="text" value="Off"/></p> <p>Tilt Flip <input type="text" value="Off"/></p> <p>Preset Speed <input type="text" value="160 deg/sec"/></p> <p>PTZ Speed Comp <input type="text" value="Off"/></p> <p>Initial Position <input type="text" value="Last MEM"/></p> <p>Motionless Preset <input type="text" value="Off"/></p> <p>D-Zoom Limit <input type="text" value="x1"/></p> <p>PTZ Motion Sync <input type="text" value="Off"/></p> </div> <ul style="list-style-type: none"> ■ Pan/Tilt limit: Set the pan/tilt limit ■ Pan/Tilt flip: Set Pan/Tilt flip ■ Preset Speed: Set the rotation speed of the cradle head when Preset is executed ■ PTZ Speed Comp: Set the Pan/Tilt moving speed to vary from the zoom position ■ Initial Position: Set the camera lens to return to the last operated position or the first preset position after POWER ON 						
Exposure	White Balance	Focus	Mirror	Pan Tilt Zoom	Tally Lamp	IQ Sync										
<div style="background-color: #1a1a1a; color: white; padding: 10px;"> <p>Pan/Tilt Limit <input type="text" value="Off"/></p> <p>Pan Right Limit <input type="text" value="170"/></p> <p>Pan Left Limit <input type="text" value="-170"/></p> <p>Tilt Up Limit <input type="text" value="90"/></p> <p>Tilt Down Limit <input type="text" value="-30"/></p> <p>Pan Flip <input type="text" value="Off"/></p> <p>Tilt Flip <input type="text" value="Off"/></p> <p>Preset Speed <input type="text" value="160 deg/sec"/></p> <p>PTZ Speed Comp <input type="text" value="Off"/></p> <p>Initial Position <input type="text" value="Last MEM"/></p> <p>Motionless Preset <input type="text" value="Off"/></p> <p>D-Zoom Limit <input type="text" value="x1"/></p> <p>PTZ Motion Sync <input type="text" value="Off"/></p> </div> <ul style="list-style-type: none"> ■ Pan/Tilt limit: Set the pan/tilt limit ■ Pan/Tilt flip: Set Pan/Tilt flip ■ Preset Speed: Set the rotation speed of the cradle head when Preset is executed ■ PTZ Speed Comp: Set the Pan/Tilt moving speed to vary from the zoom position ■ Initial Position: Set the camera lens to return to the last operated position or the first preset position after POWER ON 																

		<p><Remark> First default position = Preset 0</p> <ul style="list-style-type: none"> ■ Motionless Preset: When the function is enabled, the screen will Freeze when Preset is executed. Freeze will be released after Preset is completed ■ D-Zoom Limit: Set the D-Zoom Limit, x1 - x12 ■ PTZ Motion Sync: When activated, PTZ synchronization Hour can be achieved by controlling with the Presets <p><Remark> Refer to the Preset speed setting for this feature. The speed may be adjusted automatically due to the difference of PTZ moving range</p>
7	Tally Lamp	 <ul style="list-style-type: none"> ■ Enable/ Disable Tally Light ■ Indicator Light Link Mode: Set whether the indicator is linked with RS232 command <ul style="list-style-type: none"> • Normal (Not linked): The indicator light status and mode shall be set separately. <ul style="list-style-type: none"> - When the indicator light is on and the default mode is off, additional command is required to set the indicator light mode - Setting indicator light mode when the indicator light is off will not trigger the indicator light • Link: <ul style="list-style-type: none"> - When the indicator light is on, the default mode is red light - Setting indicator light mode when the indicator light is off will turn on the indicator light
8	IQ Sync	 <p>Set IQ main synchronized device</p> <p>Available when “Exposure” and “White Balance” is set to “Auto” mode (Currently it’s the beta version. Please refer to Web Page Firmware Update Information for the official version release schedule.)</p>

5.2.7 Setting - Picture

<Remark> Preview pane is not supported when NDI is on

Picture

- Live View
- Add / Edit Users
- Settings
- Configuration
- Video
- Camera
- Picture**
- Audio
- Network
- Date / Time
- Maintenance
- About

No	Item	Function Descriptions
1	Picture Effect	Set picture effect, Off/ Neg/ Black and White
2	2D NR	2D noise reduction settings



3	3D NR	3D noise reduction settings
4	Image mode	The user may customize his/ her desired image mode
5	Image Mode Load	When no custom setting is needed, reset the picture parameters back to the factory default by selecting this item
6	Gamma	Gamma Level adjustment; Adjustable when the image mode is set to Custom
7	Brightness	Brightness adjustment of the image; Adjustable when the image mode is set to Custom
8	Hue	Hue adjustment; Adjustable when the image mode is set to Custom
9	Saturation	Saturation adjustment of the image; Adjustable when the image mode is set to Custom
10	Sharpness	Adjust the sharpness of the image

5.2.8 Setting - Audio

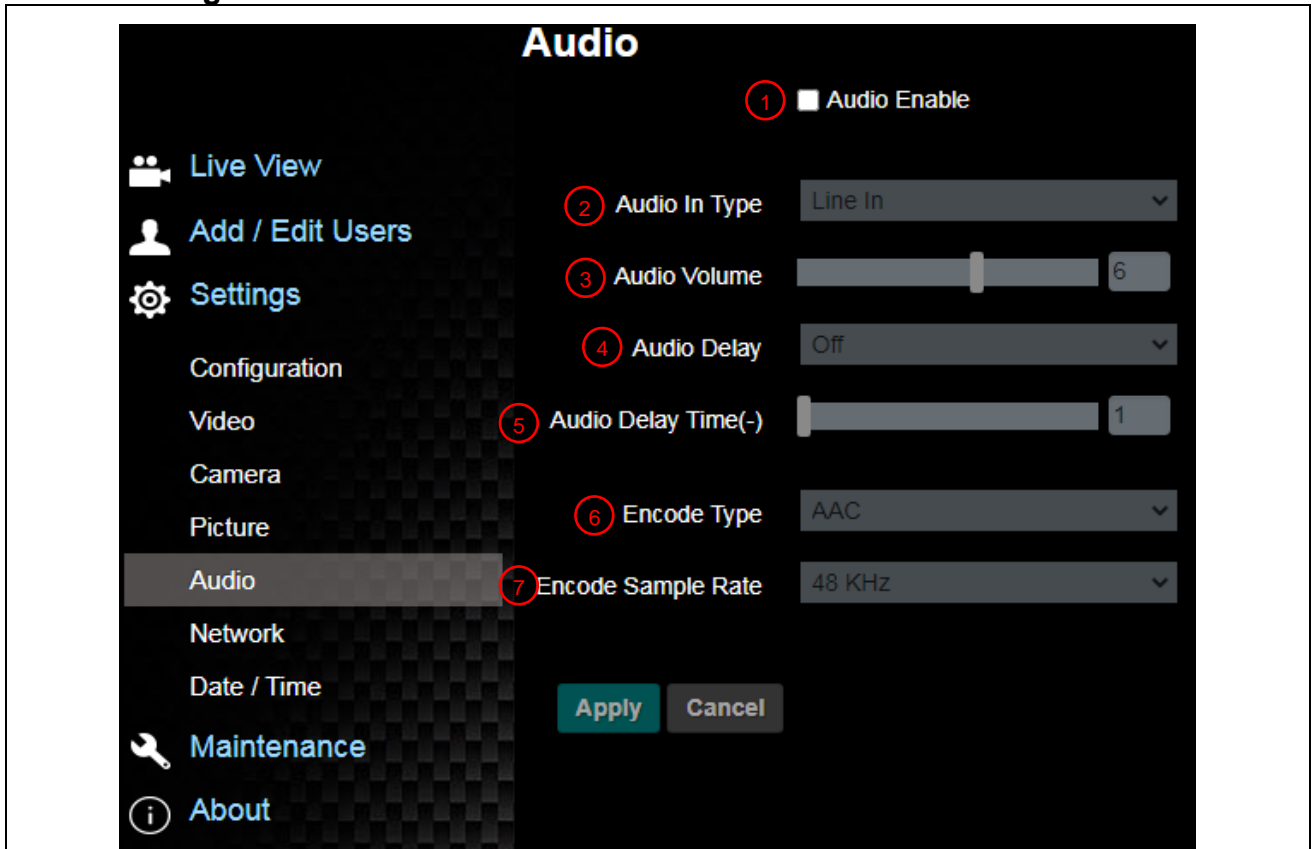

No	Item	Function Descriptions	NDI ON	NDI OFF
1	Audio Enable	Turn on/ off sound	V	V
2	Audio in Type	Set MIC In/ Line In	V	V
3	Audio Volume	Adjust Audio Volume	V	V
4	Audio Delay	Turn on/ off audio delay		V
5	Audio Delay Time(-)	Set the audio signal delay time (-1 ~ -500 ms)		V
6	Encode Type	AAC / G.711		V
7	Encode Sample Rate	Set Encode sample rate > 48 KHz (AAC) > 44.1 KHz (AAC) > 16 KHz (AAC) > 16 KHz (G.711) > 8 KHz (G.711)		V

5.2.9 Setting - Network

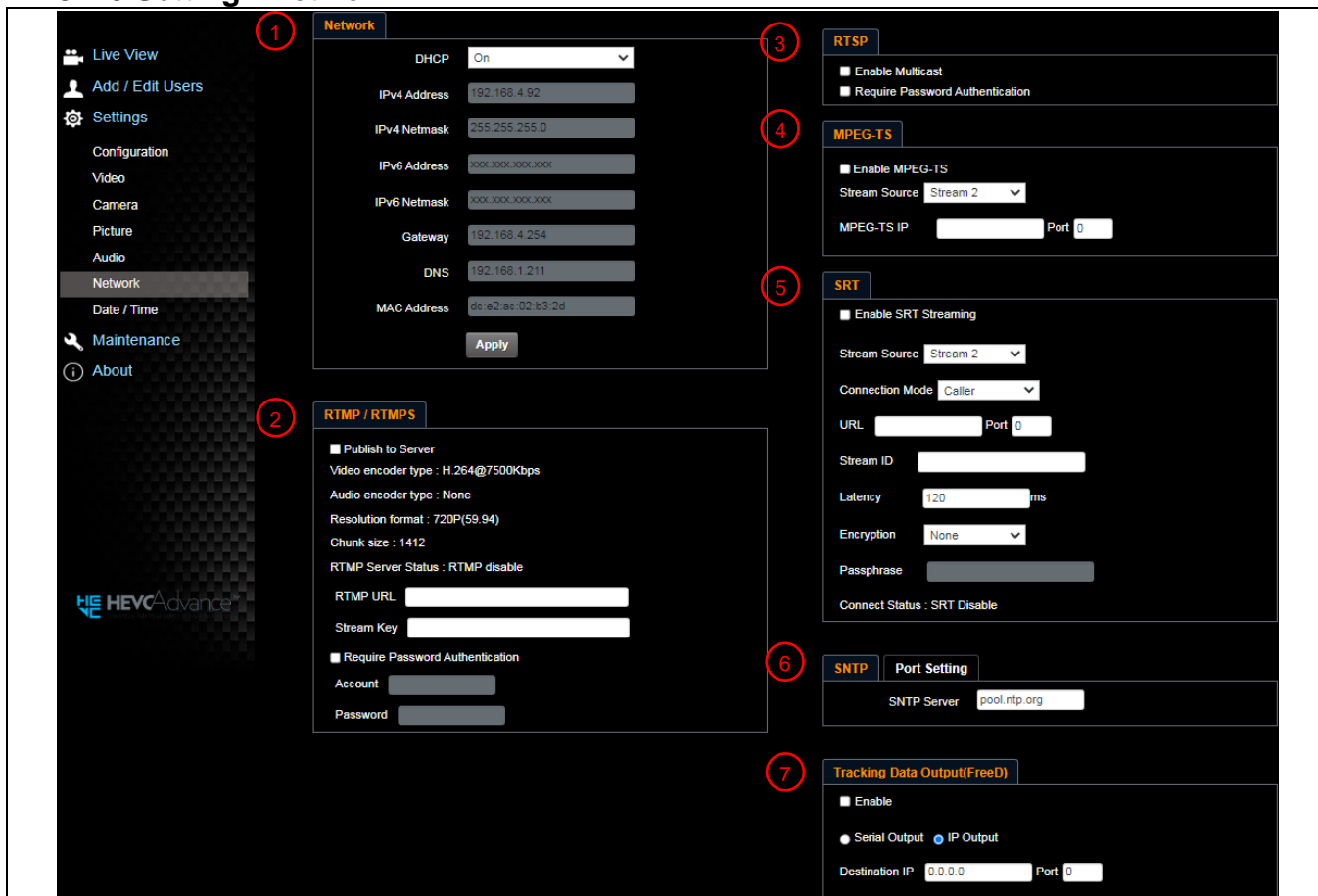

No	Item	Function Descriptions	NDI ON	NDI OFF
1	Network	Network setting of camera. Change of setting is available when DHCP function is closed.	V	V
2	RTMP/ RTMPS Setting	Copy the RTMP web address provided by the RTMP service platform and paste it to the RTMP connection address to publish the camera images on the RTMP service platform To upload to YouTube for live streaming, please refer to 5.2.8 Settings - Audio to turn on the audio function		V
3	RTSP Setting	<ul style="list-style-type: none"> ■ Enable / Disable Multicast It is suggested to enable Multicast when the number of users online watching the image simultaneously is more than 4 ■ Enable / Disable Password Authentication <ul style="list-style-type: none"> · RTSP connection format can be found in 5.1.3 Using RTSP Player to View the Images · The username/password is the same as the web login password of the camera, please refer to 5.2.3 Account Management to add/ modify account information 		V
3-1	Multicast Setting	<input type="checkbox"/> Enable Multicast IP Setting 239.255. 0.1 Netmask 255.255. 0.0	V	
		Enable Multicast to proceed settings		
3-2	Discovery Server	<input type="checkbox"/> Discovery Server Server IP [Input Field]	V	
		Check to enter the Server IP address		

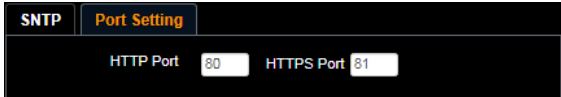
4	MPEG-TS Setting	Set MPEG-TS format <Remark> The port setting range 1025 ~ 65535 <Remark> The following port is used by the camera. Setting of the port may not connect correctly 1935, 8080, 8554, 8556, 8557, 9090		V
5	SRT Setting	1. Set the field of SRT and then check the item to open SRT streaming After the SRT streaming is opened, it will be connected automatically upon startup 2. The port setting range 1025 ~ 65535 <Remark> The following port is used by the camera. Setting of the port may not connect correctly 1935,8554,8555,8556,8557 3. Delay time is for 20 to 8000 microseconds. The default value is 120 microseconds		V
6	SNTP/ Port Setting	1. Set SNTP Server IP  2. Set HTTP port. The default Port value is 80 Set HTTPS port. The default Port value is 81 <Remark> Change of setting is available only when DHCP function of camera is closed	V	V
7	Tracking Data Output (FreeD)	When enabled, PTZ position information can be reported when the camera moves 1. Serial Output: Please set the protocol to VISCA and the baud rate to 38400 2. IP output: Set the IP address and port 3. The port numbers should be > 1024. 1935, 8555, 8556, 8557 cannot be used <Remark> When Tracking Data Output is enabled, the camera performance may be affected.	V	V

5.2.10 Setting - Time

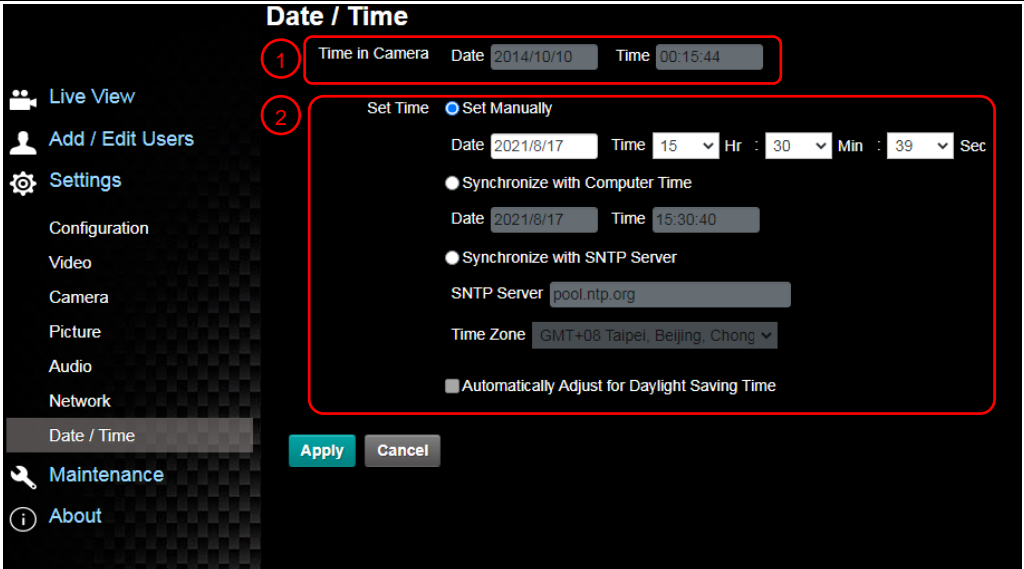

No	Item	Function Descriptions
1	Time in Camera	Display the date and time of the camera
2	Set Time	<ul style="list-style-type: none"> ■ Manual Configuration: Set time manually ■ Synchronize with computer time: Set the camera time according to the computer time ■ Synchronize with SNTP server: Set the camera time synchronously with the SNTP server <Remark> SNTP server address: Please change in network setting

5.2.11 Setting - Maintenance - Upgrading Firmware

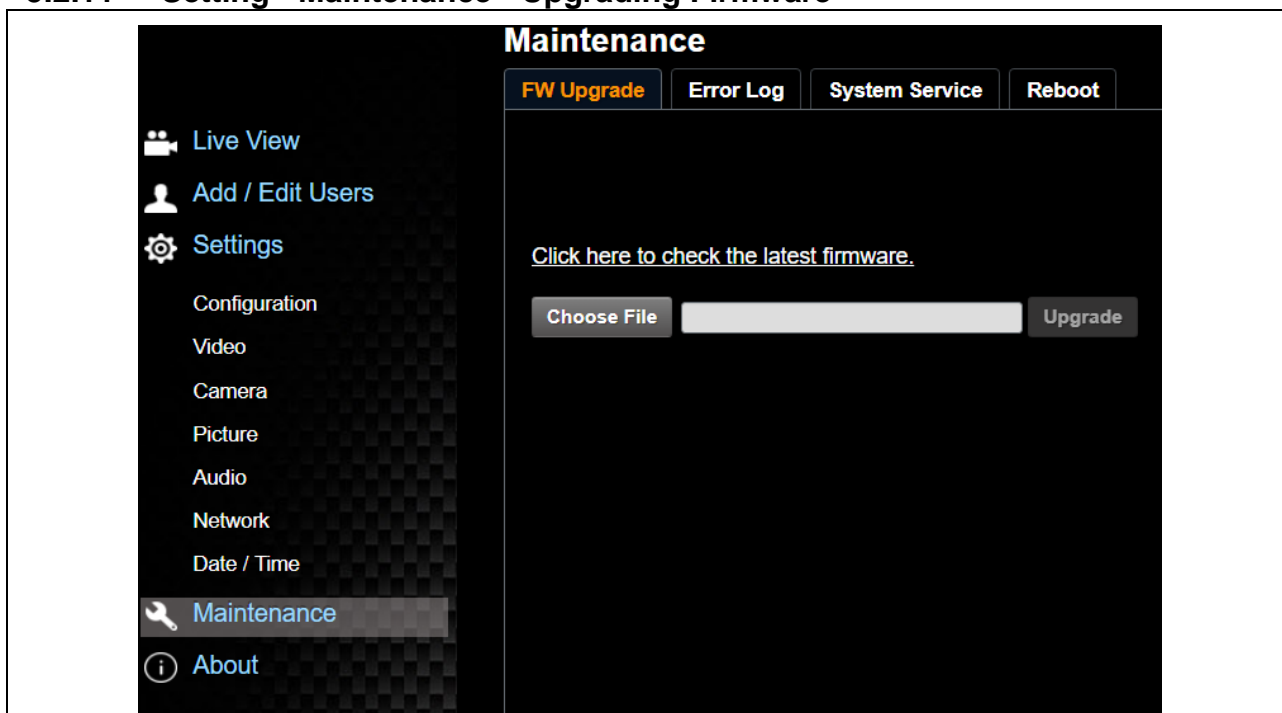

No	Item	Function Descriptions
1	FW Upgrade	<ul style="list-style-type: none"> Click the link to check the latest firmware version. Click [Choose File] to select the firmware file, and click [Upgrade] to update the firmware For the upgrade method, please download the FW upgrade manual from Lumens official website <p><Remark> Update takes about 2 - 3 minutes <Remark> Please do not operate or turn off the power of the device during the update to avoid firmware update failure</p>

5.2.12 Setting - Maintenance - Incident Log

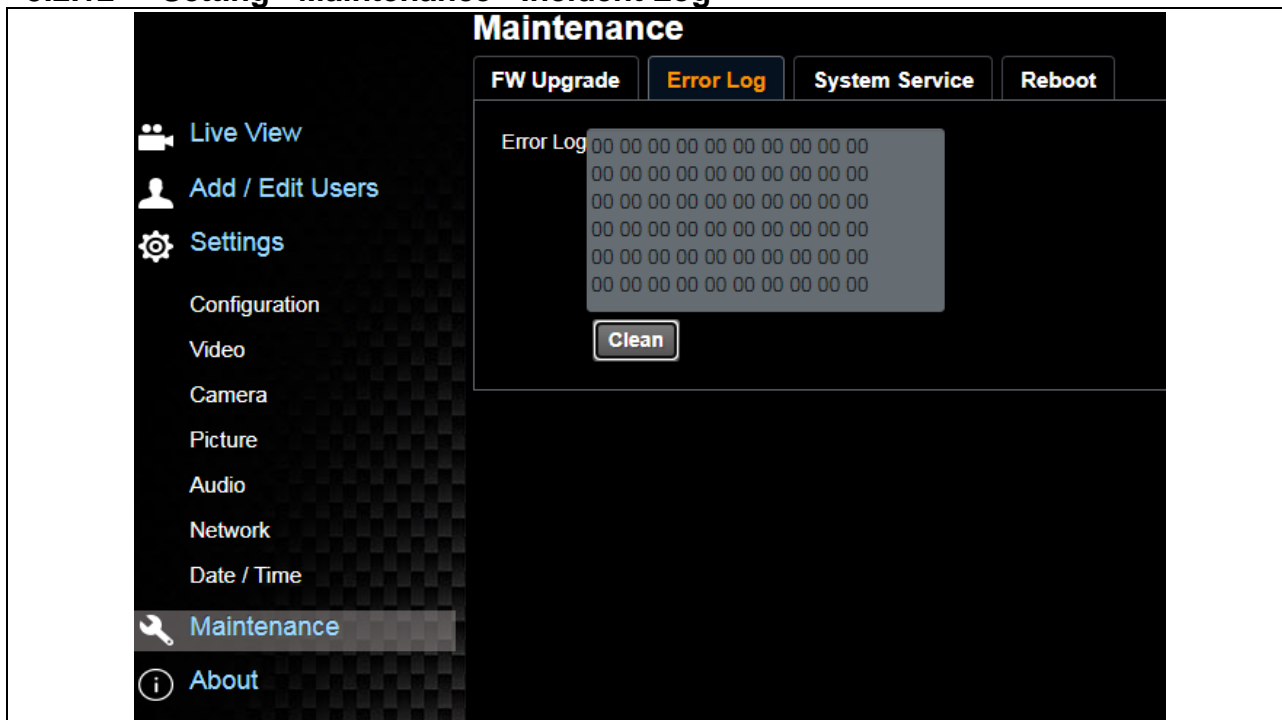

No	Item	Function Descriptions
1	Error Logs	If the camera encounters errors, an error code log will be established <Remark> When an error code appears, the user may try to clear and confirm if the error will repeat itself

5.2.13 Setting - Maintenance - System Service

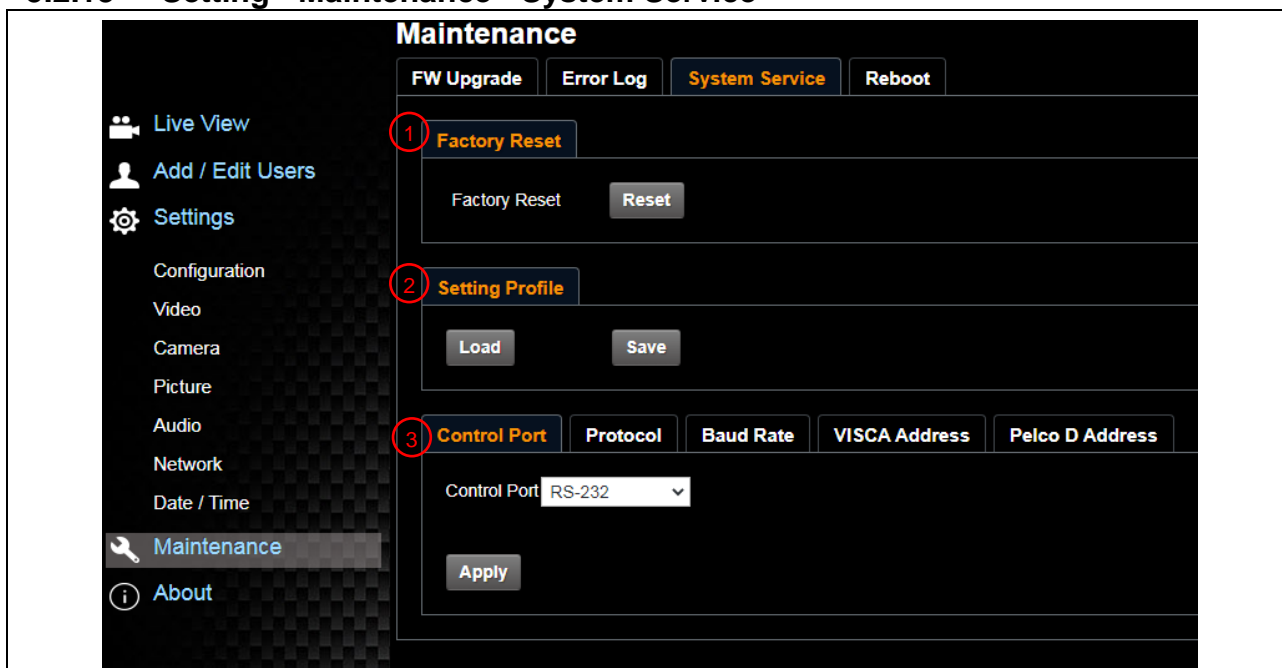

No	Item	Function Descriptions
1	Factory Reset	Select the reset button to resume the factory default setting as the web page setting
2	Setting Profile	The web page setting parameters can be exported from the computer and imported/applied to another camera
3	Communication protocol related settings	Communication protocol related settings for the use of connecting RS-232/RS-422 communication

5.2.14 Setting - Maintenance - Reboot

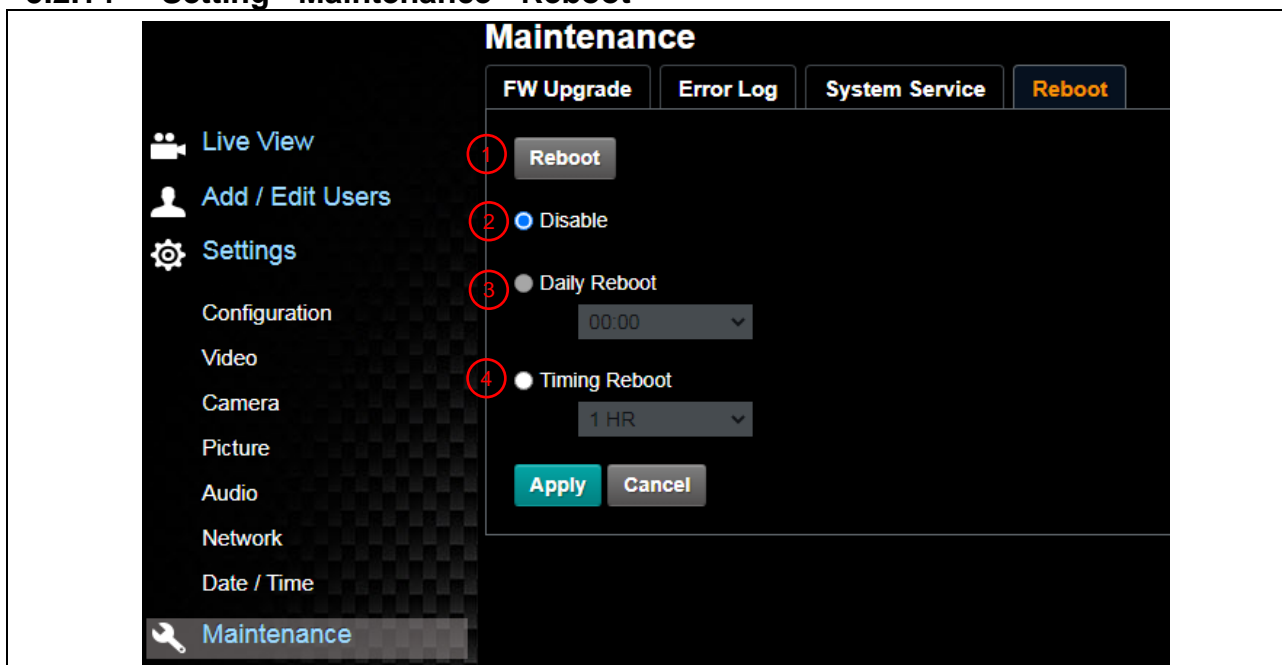

No	Item	Function Descriptions
1	Reboot	Reboot immediately
2	Disable	Disable the reboot settings
3	Daily Reboot	Set the daily reboot time <Remark> Please go to 5.2.10 Settings - Time to complete the SNTP server synchronization to set daily reboot
4	Timing Reboot	Set the timing reboot time

5.2.15 About

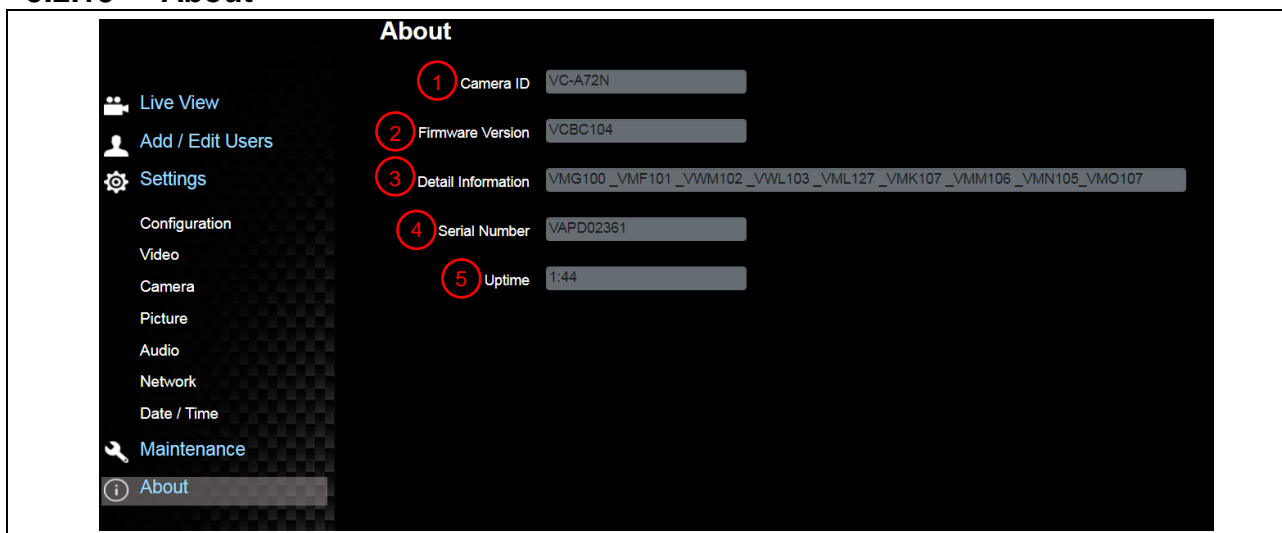

No	Item	Function Descriptions
1	Camera ID	Display the camera name
2	Firmware Version	Display the firmware version of the camera
3	Detail Information	Display firmware version-related information
4	Serial Number	Display the camera serial No.
5	Uptime	Display the running time of the camera (the time will be reset when the camera is rebooted or turned off)

Chapter 6 DIP Switch Setting

6.1 DIP SWITCH

6.1.1 OUTPUT Switch (Switch to different output resolutions)

To switch via the OSD/ RS-232 Command is also available based on the last executed action

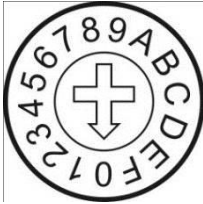

ID	Output Resolution	Frame Rate
0	3840x2160p	59.94
1		50
2		29.97
3		25
4	1920x1080p	59.94
5		50
6		29.97
7		25
8	1280x720p	59.94
9		50
A		Reserved
B		Reserved
C	1920x1080i	59.94
D		50
E	Reserved	Reserved
F		

6.1.2 IR SELECT (Selected by Remote control)

When using the remote control, please make sure the settings of IR SELECT and the Camera Select of the remote control are consistent



ID	Setting
1	
2	
3	



Chapter 7 Troubleshooting

This chapter describes problems you may encounter while using VC-A71SN. If you have questions, please refer to related chapters and follow all the suggested solutions. If the problem still occurred, please contact your distributor or the service center.

No.	Problems	Solutions
1.	Boot without power signal	<ol style="list-style-type: none"> 1. Make sure you have plugged in the power cord. 2. When using a PoE connection, ensure that the power supply supports POE++ (IEEE802.3bt) routers or hubs
2.	There is no image output from VC-A71SN	<ol style="list-style-type: none"> 1. Check the power supply or PoE supply functions. 2. Confirm the output signals are in streaming output. 3. Confirm whether the camera resolution can be used together with the monitor equipment <ul style="list-style-type: none"> ■ If 4k output, confirm the monitor equipment supports 4K output 4. Replace the cables and make sure they are not faulty.
3.	RS-232 cannot be controlled	<ol style="list-style-type: none"> 1. Confirm the connection is correct (RS-232 In/ Out) 2. Please make sure the Baud rate setting is the same as the control equipment
4.	Whether the Internet can be used for operation	Please refer to Chapter 5 Network Function Description for the Internet usage
5.	Tally lamp is not working when applying RS232 setting	<p>Please make sure if the Tally lamp function is enabled from the setting menu or web page.</p> <ul style="list-style-type: none"> ■ Setting Menu: System - Tally Lamp ■ Web page: Setting - Camera - Tally Lamp
6.	The camera does not save the relevant parameters (PTZ, AWB ...) after reboot	<p>Please make sure if the Initial Position is set to Last Operated Position from the setting menu or web page</p> <ul style="list-style-type: none"> ■ Setting Menu: System - Initial Position ■ Web page: Setting - Camera - Pan Tilt Zoom
7.	Tracking Data Output is delayed or not updated	<p>Please confirm that the camera is not in the following status</p> <p>The following function settings may cause data output to be delayed or not updated:</p> <ul style="list-style-type: none"> - Modify output resolution - Modify camera mode - Modify HDMI format - Turn on the setting menu - Streaming Setting - Audio Source Setting
8.	The NDI/ Onvif software cannot find the machine	Either NDI or ONVIF can be used. Please ensure the settings on [Setting] > [Video] > [NDI HX] page is set properly
9.	Unstable network connection when using PoE devices	<ol style="list-style-type: none"> 1. Confirm the PoE switch meets the camera's required specification (PoE++ IEEE 802.3bt). 2. Disable the EEE (Energy Efficient Ethernet) function on the switch.

Chapter 8 Safety Instructions

Always follow these safety instructions when setting up and using the Document Camera:

1 Operation

- 1.1 Please use the product in the recommended operating environment, away from water or source of heat
- 1.2 Do not place the product on a tilted position or unstable trolley, stand or table.
- 1.3 Please clean the dust on the power plug prior to usage. Do not insert the product's power plug into a multiplug to prevent sparks or a fire.
- 1.4 Do not block the slots and openings in the case of the product. They provide ventilation and prevent the product from overheating.
- 1.5 Do not open or remove covers, otherwise it may expose you to dangerous voltages and other hazards. Refer all servicing to licensed service personnel.
- 1.6 Unplug the product from the wall outlet and refer servicing to licensed service personnel when the following situations happen:
 - If the power cords are damaged or frayed.
 - If liquid is spilled into the product or the product has been exposed to rain or water.

2 Installation

- 2.1 For security considerations, please make sure the standard hanging rack you bought is in line with UL or CE safety approbations and installed by technician personnel approved by agents.



3 Storage

- 3.1 Do not place the product where the cord can be stepped on as this may result in fraying or damage to the lead or the plug.
- 3.2 Unplug the product during thunderstorms or if it is not going to be used for an extended period.
- 3.3 Do not place the product or accessories on top of vibrating equipment or heated objects.

4 Cleaning

- 4.1 Disconnect all the cables prior to cleaning and wipe the surface with a dry cloth. Do not use alcohol or volatile solvents for cleaning.

■ Precautions

	This symbol indicates that this equipment may contain dangerous voltage which could cause electric shock. Do not remove the cover (or back). No user-serviceable parts inside. Refer servicing to licensed service personnel.		WARNING
			This symbol indicates that there are important operating and maintenance instructions in this User Manual with this unit.

■ **Battery Warning (for products or accessories with batteries)**

General Safety Warnings:

- Do not heat or dispose of the battery in fire, as it may explode or leak.
- Avoid short-circuiting: Do not connect the positive and negative terminals directly or use metallic objects to connect them.
- Do not disassemble, crush, puncture, or modify the battery.
- Do not immerse the battery in water or any other liquids.

Usage and Storage Warnings:

- Do not store the battery in high-temperature environments (above 60°C) or in areas with high humidity.
- Keep away from direct sunlight and heat sources.
- If not in use for a long period, remove the battery and store it in a cool, dry place.

Disposal and Recycling Warnings:

- Do not dispose of the battery in household waste; follow local regulations for proper disposal and recycling.
- If leakage occurs, avoid contact with the leaked substance and clean the affected area immediately.

Child Safety Warnings:

- This product contains a button battery. Ingestion of a button battery can cause severe internal burns within 2 hours and may result in death.
- If a battery is swallowed or if internal battery material is contacted, seek medical attention immediately.
- Store batteries (whether new or used) in a place that is out of reach of children.
- If the battery compartment does not close securely, stop using the product and keep it away from children.

■ FCC Warning

This equipment has been tested and found to comply with the limits for a Class A digital device, pursuant to part 15 of the FCC Rules. These limits are designed to provide reasonable protection against harmful interference when the equipment is operated in a commercial environment.

Notice :

The changes or modifications not expressly approved by the party responsible for compliance could void the user's authority to operate the equipment.

■ **IC Warning**

This digital apparatus does not exceed the Class A limits for radio noise emissions from digital apparatus as set out in the interference-causing equipment standard entitled "Digital Apparatus," ICES-003 of Industry Canada.

Cet appareil numérique respecte les limites de bruits radioélectriques applicables aux appareils numériques de Classe A prescrites dans la norme sur le matériel brouilleur: "Appareils Numériques," NMB-003 édictée par l'Industrie.

■ **EN55032 CE Warning**

Operation of this equipment in a residential environment could cause radio interference.

Supplier's Declaration of Conformity 47 CFR § 2.1077 Compliance Information

Manufacturer : Lumens Digital Optics Inc.

Product Name : VC-A71SN

Model Number : PTZ Video Camera

Responsible Party – U.S. Contact Information

Supplier : Lumens Integration, Inc.

4116 Clipper Court, Fremont, CA 94538, United States

e-mail : support@mylumens.com

FCC Compliance Statement

This device complies with Part 15 of the FCC Rules. Operation is subject to the following two conditions : (1) This device may not cause harmful interference, and (2) this device must accept any interference received, including interference that may cause undesired operation.

Copyright Information

Copyrights © Lumens Digital Optics Inc. All rights reserved.

Lumens is a trademark that is currently being registered by Lumens Digital Optics Inc.

Copying, reproducing or transmitting this file is not allowed if a license is not provided by Lumens Digital Optics Inc. unless copying this file is for the purpose of backup after purchasing this product.

In order to keep improving the product, the information in this file is subject to change without prior notice.

To fully explain or describe how this product should be used, this manual may refer to names of other products or companies without any intention of infringement.

Disclaimer of warranties: Lumens Digital Optics Inc. is neither responsible for any possible technological, editorial errors or omissions, nor responsible for any incidental or related damages arising from providing this file, using, or operating this product.